

MICROCONTROLLER BASED SPEED CONTROLLER OF ONE PHASE INDUCTION AC MOTOR IN ESCALATORS

by Endah Setyaningsih

Submission date: 02-Sep-2021 09:23PM (UTC+0700)

Submission ID: 1640101332

File name: er_Based_Speed_Controller_of_Escalator_Sarah_Printed_to_PDF.pdf (646.09K)

Word count: 2336

Character count: 15546

MICROCONTROLLER BASED SPEED CONTROLLER OF ONE PHASE INDUCTION AC MOTOR IN ESCALATORS

Hadian Satria Utama ^{1>}, Edward Naulibasa Lie²¹, Pono Budi Marjoko^{3>}

^{1,2>}Universitas Tarumanagara, Jakarta, Indonesia

^{3>}universitas Pelita Harapan, Banten, Indonesia

e-mail: hs_utama@yahoo.com

Abstract

An escalator is a vertical transportation equipment for people. Their utilization as substitute for stairways makes escalators as mandatory units in shopping centers, airports, and high-rise buildings. However, the use of electrical power required in an escalator is enormous, ranging from 5kWh up to 15kWh. Therefore, a technique of electrical energy savings for escalators is needed. One technique is to control the motor speed of the escalator. In this final project, a controller for single phase AC induction motor speed for an escalator model based on microcontroller is designed. The microcontroller provides a trigger voltage to flow electrical current into the motor. The microcontroller uses AC induction motor coupling circuit as a switch for the AC current to flow. The longer the coupling of AC induction motor is activated, the greater the supply voltage and the faster the rotation of the motor. Thus, the speed of the single-phase AC induction motor in this design can be controlled. In this project, the escalator model has two levels of speed selection. When no one is on the modeling escalator, the system can use lower speed and when there are people using the escalator, the system can use higher speed. Because this scheme, this system is capable of saving of up to 75% electricity used compared with modeling escalator that does not use designed system.

Keywords: escalator, microcontroller, AC induction motors, savings

INTRODUCTION

An escalator is a transportation technology in the form of a conveyor for transporting people. Escalators are used in shopping centers, airports, and high rise buildings. Escalators use induction AC motors for the drivers. An induction AC motor is an AC electrical motor, called induction AC motors since they work based on electromagnetic induction. The electromagnetic induction produces rotating magnetic field, causing the motor rotor to rotate. A major problem in using escalator is the use of enormous electrical energy of about 5 to 15 kWh, especially those escalators in shopping centers or airports which have to be active continuously all the time during operation hours or even 24 hours a day. The fact is, escalators are not being used by people all the time. If this is done continuously then there will be a waste of huge electrical energy. Therefore, an electrical energy saving system in escalator is needed. One way to do it is by controlling the speed of the induction AC motor AC in the escalator. The speed of an induction AC motor can be controlled using an electronic circuit with a microcontroller at the heart of the system, interconnected with the induction AC motor coupling circuit. Microcontroller reads reference signals derived from AC voltage frequency, such that the microcontroller clock can be synchronized with the AC voltage frequency. The microcontroller in turn produces trigger signals to turn the induction AC motor coupling on and off. The electrical current and voltage supplied to the induction AC motor is controlled by the motor coupling. That way the magnitude of current and voltage supplied to the motor are affected by the length of the on time of the motor coupling. Therefore, using this technique the speed of the motor can be controlled. The speed controller of the one phase induction AC motor is utilized when there is no person on the escalator by adjusting the motor speed level to a lower value. If a passing person is read by the sensor in the escalator, then the

motor can use a faster speed level until the person reach the other end of the escalator. Using this technique there is a substantial electrical energy saving in the use of the escalator as a whole.

The goal of this design is to control the speed of the one phase induction AC motor in the escalator model using a microcontroller based electronic system. The system escalator model using induction AC motor speed controller should provide electrical energy cost saving in the escalator model using induction AC motor speed controller compared to when the escalator model is not using induction AC motor speed controller.

A microcontroller is a single electronic chip containing an integrated processor, memory, and input/output (I/O). A microcontroller has the ability to control electronic circuits, thus microcontrollers can be regarded as mini computers. A microcontroller is capable of storing programs and processed them according to the program used. A microcontroller becomes the core of the induction AC motor speed controller in this design. A microcontroller usually has a central processing unit (CPU), timer, counter, AOC, DAC, memori, input/output (I/O) ports, serial port, interrupt logic, and oscillator circuits [1]. The block diagram of a microcontroller is shown in Figure 1.

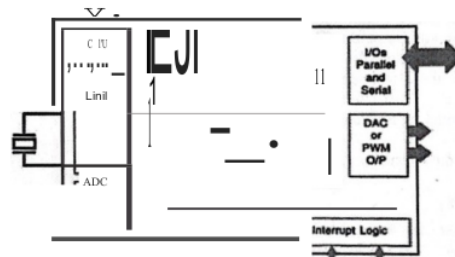

Figure 1. Block diagram of a microcontroller

Induction AC motor coupling is an electronic circuit that has the capability to control the magnitude of AC voltage using DC voltage trigger input. This coupling may be called AC motor driver with a controller of a unit controller using DC source. The induction AC motor coupling consists of an optocoupler and a TRIAC.

An optocoupler is an electronic component in the form of an IC chip [4]. Inside this IC chip there are transmitter dan receiver circuits. The optocoupler consists of an infrared LED as the transmitter and a semiconductor component that is sensitive to light (photoTRIAC) as the receiver. The optocoupler works based on triggers from optical light. Therefore, the high power AC circuit and the low power DC circuit do not have direct electrical connection. This optocoupler is the interface between the DC controller circuit and the AC motor circuit. As a result, if there is any damage in the motor circuit, then the control circuit is not affected. An optocoupler is shown in Figure 2.

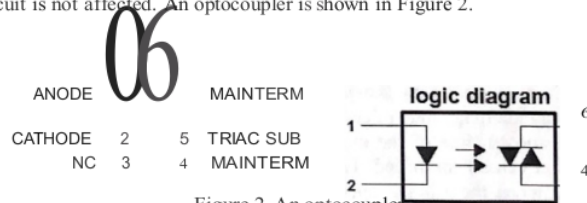

Figure 2. An optocoupler

A TRIAC is a kind of thyristor that has bidirectional characteristics. Bidirectional characteristics means TRIAC is a two way switch that is capable of flowing electrical current in two directions when it is triggered. The TRIAC has three terminals, which are main terminal 1, main terminal 2, and gate. TRIAC will only active when it has been triggered at its gate. Once a TRIAC is activated, the TRIAC will be conducting as long as the electrical current is flowing until the AC current crosses zero point. Therefore, TRIAC can only be deactivated or in the position of blocking the electrical current when the TRIAC crosses zero point [3]. A TRIAC is shown in Figure 3.

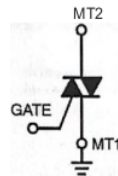

Figure 3. A TRIAC

A schmitt trigger is an electronic component for converting a sinusoidal signal to a square signal. The schmitt trigger is a type of comparators, but the schmitt trigger has two different threshold voltages (upper and lower threshold voltages) [2]. When an input voltage exceeds the upper threshold voltage then the resulting output will be high in the non-inverting model or low in the inverting model, while when the input voltage is lower than the lower threshold voltage then the output will change from the previous condition. The trigger will not change when the input voltage falls in the dead band (between upper threshold and lower threshold). This characteristic is called hysteresis. This characteristic can eliminate noise and produces better square signals compared to regular comparators. The comparison between an output signal using a regular comparator and an output signal using a schmitt trigger is shown in Figure 4.

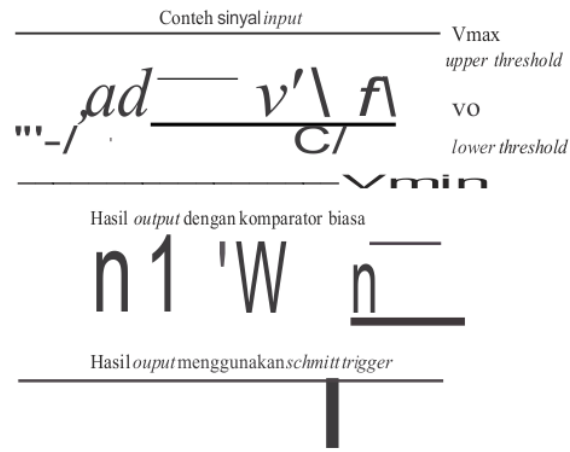

Figure 4. Comparison between a schmitt trigger and a regular comparator.

DESIGN

The design started with designing and building the escalator model. The escalator was designed using two iron plates whose ends are connected with a roller. Then, the roller is layered with an anti-slip mat as the base of the escalator. The escalator model is shown in Figure 5. Next, the one phase induction AC motor is connected to the escalator model.

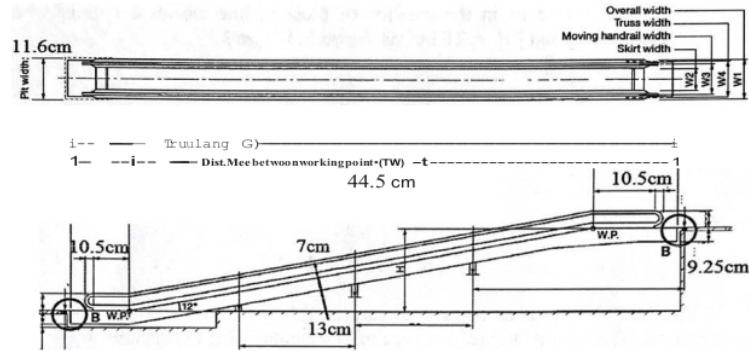

Figure 5. Escalator model design

The design is proceeded by connecting the designed motor speed controller system to the escalator model. The designed system provides two choices of speed level desired, from speed level one up to speed level seven. When the escalator is activated, the motor starts rotating with speed level one. As soon as a person is detected by the detector/sensor, the motor changes the rotating speed to the second speed level. The motor will go back to the first speed level speed level when the person passes the second detector/sensor. The motor speed is read by a tachometer and the motor speed will be displayed on a liquid crystal display (LCD) screen. The escalator can also move up or down. If the up switch is chosen, then the motor will start rotating in the clockwise direction (CW). If the down switch is chosen, then the motor will start rotating in the counter clockwise direction (CCW). The escalator is equipped with an emergency evacuated push button, where this button will make the escalator move in the down direction and use the highest speed level even there is no one using it. The escalator is also equipped with an emergency stop push button, where this button will stop the motor immediately.

The realization of the complete system is done by interconnecting all I/O sub modules with the ATmega 16a microcontroller module and writing the program using an integrated software called CodeVisionAVR that is downloadable into the microcontroller using K125-R downloader module. The output of reference signal trigger module containing schmitt trigger is connected to input pin PD.2 of microcontroller which functions as external interrupt 0. The output pair of people detector/sensor module sensor are connected to input pin PA.3 and PA.2 of microcontroller which functions as analog to digital converter (ADC) inputs. The sensor provides voltage change at its outputs when it is blocked by an object. The CW/CCW output switch button is connected to pin PD.5 of microcontroller and output PD.6 of microcontroller is connected to the CW/CCW switch input module containing relay for changing the direction of motor. The output of motor speed measuring module is connected to pin PA.0 of microcontroller which functions as

analog to digital converter (ADC) inputs for measuring the voltage change in the induction AC motor. LCD 16x2 is connected to PORT.C of microcontroller. The 4x4 keypad is connected to PORT.B of microcontroller. Pin PD.7 is connected to the input of induction AC motor coupling and the output of the induction AC motor coupling module is connected to the one phase induction AC motor Panasonic Inductive Reversible M66A36B.

After interconnecting all sub modules together, the next is downloading the program into the ATmega 16a microcontroller. First, the program initializes all microcontroller I/Os. Then, the beginning of the program will display a line of text on the LCD "Speed I: Lv." on the screen. User may enter the speed level desired from level 1 up to level 7 using the keypad. Next, the LCD displays "Speed II: Lv." menu. User may again enter the speed level required. User may select "back" for selecting speed level I&II or "next" to proceed to the display that shows the induction AC motor speed in rotations per minute (RPM) on the LCD screen.

After selecting the speed, user select "ok" to start activating the motor. As soon as the "ok" button is pressed, the program immediately converting speed level I&II which are entered as timer values which has to be adjusted. Then, the program will check whether the switch is in the position of CW or CCW direction. CW is the direction for escalator going up and CCW for escalator with down director. After selecting directions, the initial condition of the timer is initialized using conversion level conversion value to speed level value I. The program starts activating external interrupt 0 and the interrupt will happen when in the output of reference signal trigger module there is a change from logic 0 to 1. When the interrupt happens, the timer 1 is activated and the timer 1 interrupt was also activated. The timer 1 will move until overflow. When overflow happens, the timer 1 interrupt will work. Then the timer is turned off, the motor is activated for 100 us, and the motor is turned back off. The motor was only activated for 100us since TRIAC characteristic which still conducting voltage until reaching the zero point in AC signal [3]. The bigger the timer 1 value, the faster timer 1 will overflow and the reverse applies. The faster the timer overflow then the motor will be triggered faster and the bigger also the voltage received by the motor. A comparison of the resulting timer value in the waveform to AC signal produced is shown in the Figure 6.

External interrupt will repeat continuously every time when a sinusoidal signal hits the upper threshold voltage from inverting the schmitt trigger [2]. The upper threshold voltage is 8.8V with input voltage 15V. Thus, the external interrupt comes at every 2.93ms position in the in the period. The external interrupt trigger point is shown in Figure 7 and the block diagram of the complete system is shown in Figure 8.

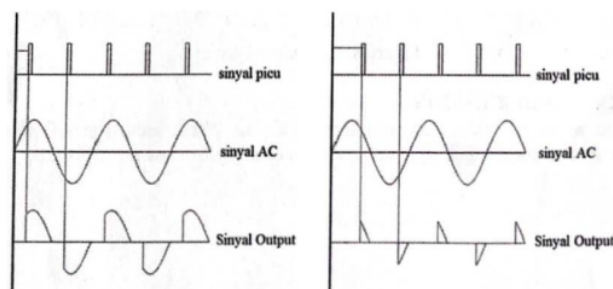
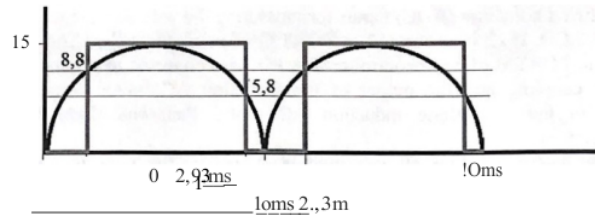

Figure 6. Large timer value (left) and small timer value (right) [3].



Titik picu external interrupt

Figure 7. External interrupt trigger point of the reference signal trigger module.

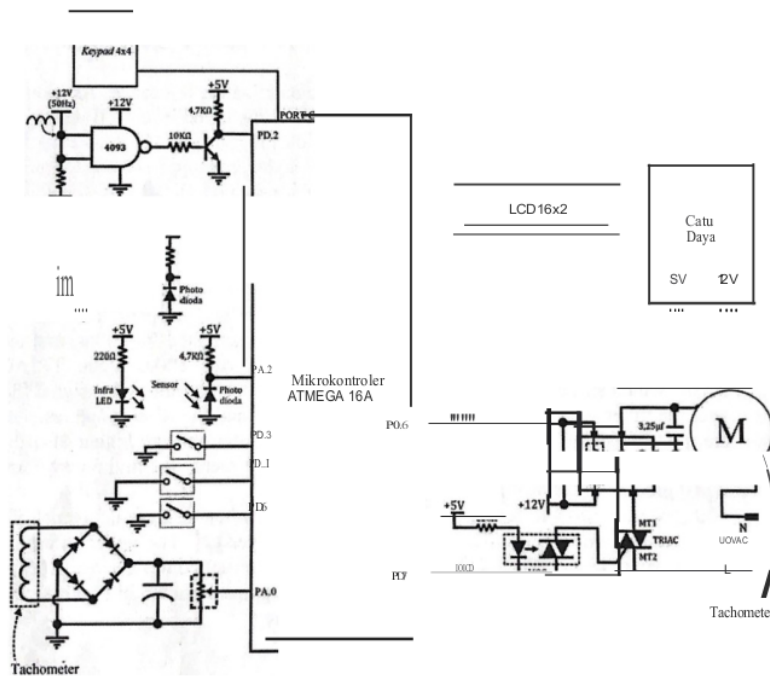

Figure 8. Complete system

RESULTS AND DISCUSSION

The result of the microcontroller based one phase induction AC motor speed controller system complete design on the escalator model is shown in Figure 9.

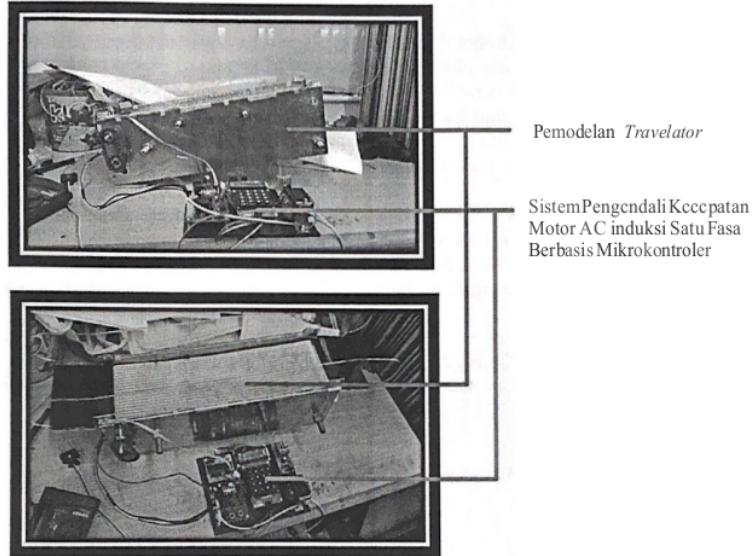

Figure 9. The one phase induction AC motor speed controller complete system and the escalator model

Results showing the change in values of voltage, current, power, and motor speed based on microcontrollers timer values obtained is shown in Table 1.

Speed Level	1	2	3	4	5	6	7
Voltage (V)	52	56,9	59	61,6	72,6	85,5	164
Current (mA)	26	27	27	28	29	30	50
Input power (Watt)	1,3	1,54	1,59	1,84	2,1	2,55	8,2
Timer value (Hex)	ICFF	1FFF	20FF	22FF	26FF	2BFF	80FF
Speed (RPM)	9	15	27	32	34	36	39
Frequency (Hz)	50	50	50	50	50	50	50

Calculation in electrical energy cost saving is done for illustration purpose and performed using typical working hours in a shopping mall. The mall opens 12 hours a day (10.00 - 22.00), 300 persons a day, power Level 7 = 8.3Wh, power Level 1 = 1.4Wh, time per person is 44.5 cm: 3.4 cm/second = 13 seconds, and the electrical utility cost in June 2015 (PLN) is Rp 1,524.24 per kWh. For escalator model without the designed system, one day usage is 12 hours x 8.3 Wh = 99.6 Wh, one month is 99.6Wh x 30 days = 2.988 kWh, and the electricity cost per month is 2.988 kWh x Rp. 1,524.24 = Rp. 4,554.429. Now, for the escalator model with the designed system, using level 7: 300 person x 13 seconds = 1 hour 12 minutes, level 1: 10 hours 48 minutes, one day usage is (1 hour 12 minutes x 8.3 Wh) + (10 hours 48 minutes x 1.4Wh) = 24.27 Wh, one month is 24.27 Wh x 30 hari = 0.728 kWh, and the electrical utility cost in June 2015 (PLN): 0.728kWh x Rp. 1,524.24 = Rp 1,109.64.

CONCLUSIONS

The motor speed controller designed in this research is capable to control voltage and current supplied to the one phase induction AC motor. Therefore, the induction AC motor in the escalator model is successfully controlled. Based on the designed system test, the speed controller of the one phase induction AC motor in the escalator model can provide a substantial saving in the electrical energy cost of up to 75.64% compared to the escalator model without using the speed controller designed in this research.

REFERENCES

- [1] Hery A., Pemograman Mikrokontroler AVR ATmega 16 Menggunakan Bahasa C, Bandung: Infonatika, 2013, p. 9-11.
- [2] Wasito S., Pelajaran Elektronika: Sirkuit Arus-searah, Edisi ke-6, Jakarta: Karya Utama, 1980, p. 147-199.
- [3] Schular C.A., *Electronics: Principles and Applications*, Edisi ke-6, Singapore: McGraw-Hill Education (Asia), 2003, p. 418-421.
- [4] Schular C.A., Fowler R.J., and Hesel J.D., *Electrical Circuit Analysis* Singapore: McGraw-Hill Book Co, 1993, p. 98-101.

MICROCONTROLLER BASED SPEED CONTROLLER OF ONE PHASE INDUCTION AC MOTOR IN ESCALATORS

ORIGINALITY REPORT

7%

SIMILARITY INDEX

7%

INTERNET SOURCES

5%

PUBLICATIONS

%

STUDENT PAPERS

PRIMARY SOURCES

1

amir.dosen.akprind.ac.id

Internet Source

6%

2

www.engineersgarage.com

Internet Source

1%

3

mafiadoc.com

Internet Source

<1%

4

download.garuda.ristekdikti.go.id

Internet Source

<1%

Exclude quotes Off

Exclude matches Off

Exclude bibliography Off