



### Welcome to Journal of Theoretical and Applied Information Technology

[Home](#)

[Volumes](#)

[Submit Paper](#)

[Manuscript Status](#)

[Author Guidelines](#)

[Editorial Board](#)

[Indexing and Abstracting](#)

[Subscribe to JATIT](#)

[Contact Us](#)

Frequency : Monthly

#### [Submit Paper / Call for Papers](#)

Journal receives papers in continuous flow and we will consider articles from a wide range of Information Technology disciplines encompassing the most basic research to the most innovative technologies. Please submit your papers electronically to our submission system at [http://jatis.org/submit\\_paper.php](http://jatis.org/submit_paper.php) in an MSWord, Pdf or compatible format so that they may be evaluated for publication in the upcoming issue. This journal uses a blinded review process; please remember to include all your personal identifiable information in the manuscript before submitting it for review, we will edit the necessary information at our side. Submissions to JATIT should be full research/ review papers (properly indicated below main title in case of review paper).

Journal of Theoretical and Applied Information Technology published since 2005 (E-ISSN 1817-3195 / ISSN 1992-8645) is an open access International refereed research publishing journal with a focused aim on promoting and publishing original high quality research dealing with theoretical and scientific aspects in all disciplines of Information Technology. JATIT is an international scientific research journal focusing on issues in information technology research. A large number of manuscript inflows, reflects its popularity and the trust of world's research community. JATIT is indexed with major indexing and abstracting organizations and is published in both electronic and print format. All articles are available under [cc-by-nc-nd](#) licensing.

All technical or research papers and research results submitted to JATIT should be original in nature, never previously published in any journal or undergoing such process across the globe. All the submissions will be peer-reviewed by the panel of experts associated with JATIT. Submitted papers should meet the internationally accepted criteria and manuscripts should follow the style of the journal for the purpose of both reviewing and editing. Indexing information is found at the indexing and abstracting page of JATIT.

[What do we look for in your Research while conducting blind Peer Review](#)

#### 1) Relevance

Its contents have to be of use to anyone practicing one of the disciplines addressed by the journal.

- The paper is relevant to the technical scope of the journal and to the professional interests and activities of its audience.
- Ideally it should present new knowledge or technology that has the potential to help the reader in their professional work as practicing scientists / engineers.

#### 2) Innovation

It should present new knowledge or technology, or analyze previously known facts in a new way.

- A paper should present new knowledge or analyze previously known facts in a new way. Additionally it should take full account of previously published work on its subject.
- A case history is appropriate if it presents the application of existing technology in a new way or in a new location or environment where it has not previously been used and that requires new and previously un-used techniques or analyses.
- A review paper is appropriate if it finds connections between previously unrelated facts or commonality between previously un-compelled facts and results, or makes deductions that give the reader substantiated guidance on the accuracy and applicability of the reviewed analyses.

#### 3) Technical Detail

It should be logically sound, and it should give sufficient detail to allow the reader to replicate the work it describes and to assess its applicability to other environments.

- The research design, methods, and analyses are adequately defined and clearly described, well integrated, well reasoned, and appropriate to the aims of the project.
- The paper should present sufficient detail of the application, methods and analyses employed and results achieved to allow the reader to replicate the work described but also to evaluate its applicability to the environment and problems on which they are working.
- Statistical / Analytical tests are appropriate and the assumptions underlying the use of statistics are fulfilled by the data.
- The statistics are reported correctly and appropriately.

#### 4) Presentation and Documentation

It should present clearly and concisely in the JATIT's standard format all relevant data and information to support the conclusions and to indicate their limitations.

- The text is well written and easy to follow.
- The introduction builds a logical case and context for the problem statement.
- The problem statement is clear and well articulated.
- The data reported are accurate (e.g., the numbers add up) and appropriate; tables, graphs and figures are used effectively and agree with the text.
- The amount of data presented is sufficient and appropriate.
- Results are presented effectively; the interpretations of the results are appropriate and the conclusions accurate.
- The conclusions are clearly stated and follow from the design, methods, and results; the justification of conclusions is well articulated.
- The study limitations are discussed.
- Statistical differences are distinguished from meaningful differences.
- Practical significance or theoretical implications are discussed.
- Reference citations are complete, accurate and up-to-date. The number of references is appropriate and their selection is judicious.

#### 5) Professional Conduct ([Responsibility of Authors](#))

It must avoid commercialism and plagiarism, and must not have been published previously.

- There are no commercial references.
- There are no instances of plagiarism.
- Ideas and materials of others are correctly attributed.
- Substantial portions of the data or study should not have been previously published.

All peer review is now based on the above criterion for all submitted manuscripts

### Scope of Journal of Theoretical and Applied Information Technology

1 bidang b.pdf

1 bidang b..pdf

ilovepdf\_merged (...pdf

ilovepdf\_merged (...pdf

Show all



Welcome to Journal of Theoretical and Applied Information Technology

<a href="#">Home</a>	<a href="#">Editorial Board</a>
<a href="#">Volumes</a>	<b>PATRON</b> Prof. (R) NIAZ AHMAD FCE, MOE, Islamabad, PAKISTAN
<a href="#">Submit Paper</a>	<b>EDITOR IN CHIEF</b> Dr. SHAHBAZ GHAYYUR Department of Computer Sciecn and Software Engineering, Internaitonal Islamic University Islamabad, PAKISTAN
<a href="#">Manuscript Status</a>	<b>EDITORIAL BOARD</b> Dr. CHRISTOS GRECOS School of Computing, Engineering and Physical Sciences, University of Central Lancashire, Preston PR1 2E, UNITED KINGDOM.
<a href="#">Author Guidelines</a>	Dr. YUXIN MAO School Of Computer & Information Engineering Zhejiang Gongshang University, CHINA.
<a href="#">Editorial Board</a>	Dr. MUHAMMAD SHER Faculty of Basic and Applied Sciences, Department of Computer Science, International Islamic University, Islamabad. PAKISTAN.
<a href="#">Indexing and Abstracting</a>	Dr. ZARINA SHUKUR Computer Science Dept., Fakulti Teknologi dan Sains Maklumat, University Kebangsaan Malaysia, 43600 Bangi, MALAYSIA.
<a href="#">Subscribe to JATIT</a>	Dr. NOR AZAN MAT ZIN Department of Information Science, Faculty of Information Science & Technology, National University of Malaysia (UKM) 43600 UKM BANGI, MALAYSIA.
<a href="#">Contact Us</a>	Dr. KHAIRUDDIN BIN OMAR Faculty of Information Science and Technology, Universiti Kebangsaan Malaysia, 43600 Bangi Selangor Darul-Ehsan, MALYSIA.
<a href="#">Frequency : Monthly</a>	Dr. TENGKU MOHD. BIN TENGKU SEMBOK Faculty of Information Science and Technology Universiti Kebangsaan, Malaysia, 43600 Bangi Selangor Darul-Ehsan, MALYSIA.
<a href="#">Submit Paper / Call for Papers</a>	Dr. R. PONALAGUSAMY Department of Mathematics, National Institute of Technology, Tiruchirappalli, Tamil Nadu, INDIA.
Journal receives papers in continuous flow and we will consider articles from a wide range of Information Technology disciplines encompassing the most basic research to the most innovative technologies. Please submit your papers electronically to our submission system at <a href="http://jatit.org/submit_paper.php">http://jatit.org/submit_paper.php</a> in an MSWord, Pdf or compatible format so that they may be evaluated for publication in the upcoming issue. This journal uses a blinded review process; please remember to include all your personal identifiable information in the manuscript before submitting it for review, we will edit the necessary information at our side. Submissions to JATIT should be full research / review papers (properly indicated below main title in case of review paper).	Dr. NITIN UPADHYAY Computer Science & Information Systems Group, Birla Institute of Technology and Science (BITS), Pilani-Goa Campus, NH-17B Bypass Road, ZuariNagar, Goa, INDIA.
	Dr. A. SERMET ANAGN Eskisehir Osmangazi University, Industrial Engineering Department, Bademlik Campus, 26030 Eskisehir, TURKEY.
	Dr. YACINE LAFIFI Department of Computer Science, University of Guelma, BP 401, Guelma 24000, ALGERIA.
	Dr. JAYANTHI RANJAN Institute of Management Technology, Raj Nagar, Ghaziabad, Uttar Pradesh, INDIA.
	Dr. ADEL M. ALIMI National Engineering School of Sfax (ENIS), University of SFAX, TUNISIA.



## Welcome to Journal of Theoretical and Applied Information Technology

**Home**

For any comments, suggestions and queries , please write to the contact person at the following mailing address.

**Volumes**

### **Chief Editor**

**Submit Paper**

**Shahbaz Ghayyur**

E-mail: [editorjatit@gmail.com](mailto:editorjatit@gmail.com)

**Manuscript Status**

### **JATIT Address**

**Author Guidelines**

House No. 740, Main Road 3, G-15/1. Islamabad, PAKISTAN  
Postal Code: 44000

**Editorial Board**

Also Available via libraries .

**Indexing and Abstracting**

Contact via email at [editor](mailto:editor@jatit.org) / [managing\\_editor](mailto:managing_editor@jatit.org) at [jatit.org](http://jatit.org).

**Subscribe to JATIT**

**Contact Us**

Frequency : Monthly



Welcome to Journal of Theoretical and Applied Information Technology

## Upcoming Volume 101 2023 Issues

[Vol.101 Issues 21 & 22](#) ( [November 15 / November 30 2023](#) ) In Press

[Vol.101 Issues 21 & 22](#) ( [December 15 / December 31 2023](#) ) In Press

[Vol.102 Issues 01 & 02](#) ( [January 15 / January 31 2024](#) ) In Preparation

**AUTHORS ARE INVITED TO SUBMIT RESEARCH ARTICLES FOR UPCOMING JANUARY 2024 ISSUES OF VOLUME 101**

### JATIT VOLUME ARCHIVE

#### VOLUMES : Journal of Theoretical and Applied Information Technology (JATIT)

31<sup>st</sup> [October 2023 | Vol.101 No.20](#) (view)

15<sup>th</sup> [October 2023 | Vol.101 No.19](#) (view)

30<sup>th</sup> [September 2023 | Vol.101 No.18](#) (view)

15<sup>th</sup> [September 2023 | Vol.101 No.17](#) (view)

31<sup>st</sup> [August 2023 | Vol.101 No.16](#)

15<sup>th</sup> [August 2023 | Vol.101 No.15](#)

31<sup>st</sup> [July 2023 | Vol.101 No.14](#)

15<sup>th</sup> [July 2023 | Vol.101 No.13](#)

30<sup>th</sup> [June 2023 | Vol.101 No.12](#)

15<sup>th</sup> [June 2023 | Vol.101 No.11](#)

31<sup>st</sup> [May 2023 | Vol.101 No.10](#)

15<sup>th</sup> [May 2023 | Vol.101 No.09](#)

30<sup>th</sup> [April 2023 | Vol.101 No.08](#)

15<sup>th</sup> [April 2023 | Vol.101 No.07](#)

31<sup>st</sup> [March 2023 | Vol.101 No.06](#)

15<sup>th</sup> [March 2023 | Vol.101 No.05](#)

[Home](#)

[Volumes](#)

[Submit Paper](#)

[Manuscript Status](#)

[Author Guidelines](#)

[Editorial Board](#)

[Indexing and Abstracting](#)

[Subscribe to JATIT](#)

[Contact Us](#)

Frequency : **MONTHLY**

[Submit Paper / Call for Papers](#)

Journal receives papers in continuous flow and we will consider articles from a wide range of Information Technology disciplines encompassing the most basic research to the most innovative technologies. Please submit your papers electronically to our submission system at [http://jatit.org/submit\\_paper.php](http://jatit.org/submit_paper.php) in Microsoft or Pdf format so that they may be evaluated for publication in the upcoming issue. This journal uses a double blinded review process; please remember to include all your personal identifiable information in the manuscript before submitting it for review, we will edit the necessary information at our end. Submissions to JATIT should be full research / review papers (properly indicated below main title).

<b>Title:</b>	OPTIMIZATION OF PHOTOMETRIC QUANTITIES FOR ROAD LIGHTING FREEWAYS IN INDONESIA
<b>Author:</b>	ENDAH SETYANINGSIH, HENRY CANDRA
<b>Abstract:</b>	Road lighting is one factor affecting driving safety on the road. Inadequate lighting has the potential to cause a traffic accident based on our previous research. Moreover, many traffic accidents occur between 18.00 - 24.00 and 00.00 - 06.00, even though the traffic volume has decreased at night. In order to investigate further the case mentioned above, this paper discussed the research for the lighting system on Cikampek and Cipularang toll roads as a sample uses case. The results revealed that the lighting system in Cikampek and Cipularang toll roads does not comply with the Indonesian national standard for lighting. In addition, a Dialux software simulation was conducted to determine the most optimum photometric illuminance, including average luminance and uniformity for the road lighting in Cikampek and Cipularang toll roads. The simulation implemented seven variables of the road-lighting design, resulting in 324 scenarios giving average illuminance between 23.88 lux to 24.40 lux with minimum uniformity of 0.53 and average luminance is 1.51 cd/m <sup>2</sup> with a uniformity of 0.70. The simulation results show that if the Cikampek and Cipularang toll roads are redesigned according to the simulation results, they will be following SNI 7391: 2008 and able to reduce the risk of accidents.
<b>Keywords:</b>	Illuminance, Luminance, Road Lighting, Photometric, Uniformity
<b>Source:</b>	Journal of Theoretical and Applied Information Technology 31 <sup>st</sup> March 2023 -- Vol. 101. No. 6-- 2023

[Full Text](#)

# OPTIMIZATION OF PHOTOMETRIC QUANTITIES FOR ROAD LIGHTING FREEWAYS IN INDONESIA

ENDAH SETYANINGSIH<sup>1</sup>, HENRY CANDRA<sup>2</sup>

<sup>1</sup>Universitas Tarumanagara, Faculty of Engineering, Department of Electrical Engineering, Indonesia

<sup>2</sup>Universitas Trisakti, Faculty of Industrial Technology, Department of Electrical Engineering, Indonesia

E-mail: <sup>1</sup>endahs@ft.untar.ac.id, <sup>2</sup>henrycandra@trisakti.ac.id

## ABSTRACT

Road lighting is one factor affecting driving safety on the road. Inadequate lighting has the potential to cause a traffic accident based on our previous research. Moreover, many traffic accidents occur between 18.00 - 24.00 and 00.00 - 06.00, even though the traffic volume has decreased at night. In order to investigate further the case mentioned above, this paper discussed the research for the lighting system on Cikampek and Cipularang toll roads as a sample uses case. The results revealed that the lighting system in Cikampek and Cipularang toll roads does not comply with the Indonesian national standard for lighting. In addition, a Dialux software simulation was conducted to determine the most optimum photometric illuminance, including average luminance and uniformity for the road lighting in Cikampek and Cipularang toll roads. The simulation implemented seven variables of the road-lighting design, resulting in 324 scenarios giving average illuminance between 23.88 lux to 24.40 lux with minimum uniformity of 0.53 and average luminance is 1.51 cd/m<sup>2</sup> with a uniformity of 0.70. The simulation results show that if the Cikampek and Cipularang toll roads are redesigned according to the simulation results, they will be following SNI 7391: 2008 and able to reduce the risk of accidents.

**Keywords:** *Illuminance, Luminance, Road Lighting, Photometric, Uniformity*

## 1. INTRODUCTION

The number of traffic accidents in Indonesia is still very high. The data from the National Traffic Police Corps of Indonesia (Korlantas Polri) shows that there were 100,106 cases of accidents, with 26,416 deaths in 2013. On average, there were 11 cases, with three people dying every hour [1]. Jusuf [2] mentions that road accidents are a severe problem in Indonesia. In 2014, the police reported approximately 28,000 fatalities due to accidents on the streets and roadways of Indonesia. The fatality rate from traffic accidents per 100,000 population was about 12. This fatality rate is very high compared to neighbouring countries like Singapore (4.8) and Australia (5.2).

Traffic accidents should be given more attention in the transportation area. Some of the factors that become the cause of traffic accidents are motorcycles (Suthanaya in Jusuf et al. [2]), and underlying traffic violation behaviours and types of traffic violations committed by young motorcyclists on urban roads in Indonesia (Joewono et al. in Jusuf et al. [2]).

Santosa et al. [3] show that the traffic accidents in Indonesia between 2010 and 2014 were dominated by motorcycles, contributing to more than 70% of road traffic accidents. Road traffic accidents involving passenger cars and trucks contributed approximately 12% and 10%, respectively. Road traffic accidents involving buses and special vehicles such as three-wheelers accounted for 5% and 1%, respectively.

According to the data from PT. Jasa Marga Tbk. Purbaleunyi branch about the traffic accident on Cipularang freeways from 2013 to 2015, the type of vehicle that caused the most accidents are 'minibus,' and the four factors causing traffic accident is human factors, vehicle factors, road factors, and environmental factors. The most cause of traffic accidents is human factors [4]. Santosa et al. [3] state that most traffic accidents in Indonesia are caused by human factors (88%), and vehicle factors in traffic accidents amounted to 3%. Road and environmental factors that caused traffic accidents amounted to 8% and were mainly due to road damage and potholes, slippery roads, sharp turns, and inadequate lighting. However, this paper does not include the data to support their statement

about inadequate lighting. Furthermore, according to the driver's perception, visibility to see traffic signs, the colour of traffic signs, potholes, road medians, sign symbols, and texts is inadequate due to insufficient lighting. [5].

So inadequate road lighting causes traffic accidents. According to Santosa et al. [3], most traffic accidents occur during the daytime/working hours; 30% of accidents occur between 06.00 and 12.00, and 32% occur between 12.00 and 18.00. Most accidents occurred during rush hours when most people were on their way to work in the morning and home in the afternoon. High traffic density and congestion during these hours add to the traffic accident potential. Interestingly, the traffic accident frequency remained significantly high (23,000-24,000) from 18.00 to 24.00. This high frequency of traffic accidents coincided with a high traffic volume of people who elected to avoid the afternoon rush hour.

However, traffic accident also occurs between 00.00 to 06.00 [3]. Therefore, during the nighttime, about 38.5% of traffic accident happens. In that period, the traffic volume decreased compared to other periods. The situation also takes place on the Cipularang freeways [4]. It can be deduced that traffic accidents that occur from human factors are caused by poor visibility, which is affected by inadequate road lighting that creates eye fatigue and drowsiness. The data that support this matter cannot be obtained in Indonesia. Therefore, further study is required to investigate the effect of road lighting on traffic accidents in Indonesia.

Especially for road lighting, according to (Tetri et al. [6]), road lighting is undeniably crucial for users to observe obstacles, anticipate ahead, and avoid accidents. Road lighting reduces the number of an accident on average by 30%. While according to (Li [7]) good lighting is needed to estimate the car's speed, monitor dangerous conditions from the side, and keep a distance from other vehicles. Several studies have been conducted in Jakarta and Bandung, and the results indicate the presence of uneven illuminance on the road surface and less or excessive illumination according to the road lighting standards National Standard of Indonesia SNI 7391:2008 [8,9,10].

Inadequate road lighting is caused by low average illuminance and average luminance. Therefore, this research focuses on finding the appropriate lighting component settings to obtain sufficient average illuminance and average luminance required on toll roads to reduce the risk of

accidents. The research was realized by conducting a simulation using Dialux by taking a case study on the Cikampek and Cipularang toll roads.

## 2. CIPULARANG FREEWAYS AND NATIONAL STANDARD OF INDONESIA

The research was conducted on Cikampek and Cipularang freeways. The Cikampek freeway connects the Jakarta freeway to Cikampek, from the Cawang to the Cikampek interchange. At the same time, the Cipularang freeway connects Cikampek to Padalarang freeway from the interchanges of Dawuan to Padalarang. Some of these freeways are part of the Purbaleunyi freeway (Purwakarta-Bandung Cileunyi). The freeways have geometric road elements, including uphill, downhill, straight, and curved ones. A road with such complex geometric elements must consider the visibility of the road users that meet the safety standards [11].

In addition, the Cikampek and Cipularang freeways should have street lightings that meet the law of the Republic of Indonesia [12]. The toll roads have many 'areas with limited visibility. Therefore, the roads should also have street lightings that follow the regulation of the Ministry of Public Works and Housing of the Republic of Indonesia [13]. The National Standard of Indonesia for road lighting is still in effect because the SNI 7391: 2008 regulates urban lighting specifications. This standard is used as a reference in Indonesia's planning and application of street lighting.

Three groups of photometric quantities for international standard consists of (1) the luminance of the road surface of the carriageway for the dry surface condition, the overall uniformity of the luminance ( $U_0$ ), and the longitudinal uniformity of the luminance ( $U_l$ ), (2) Disability glare: the threshold increment (TI) and (3) Lighting of surroundings: surround ratio (SR) according to [14,15]. The visual comfort of car/motorcycle drivers is influenced by the parameters above, so by modifying these seven variables, visual comfort can be achieved. Those parameters are regulated in The National Standards of Indonesia (SNI) for toll road lighting, SNI 7391: 2008, which includes the photometric quantities such as average illuminance, average luminance, and glare, shown in Table 1 and is a standard that still applies.

Based on the above analysis, a simulation was carried out using Dialux software to obtain optimization of photometric quantities for road lighting freeways in Indonesia. The simulation using the Dialux software gives the following results, which are discussed in more detail below. The

existing lighting condition on Cikampek and Cipularang freeways has an average illuminance value ( $E_{avg}$ ) between 6 - 10 Lux [16]. The average illuminance value varied, caused by using different lamps and Correlated Color Temperature (CCT). Those are High-Pressure Sodium (HPS) with CCT reddish white and LED lamps with CCT bluish white and different wattage lights, different mounting heights, and different installations. Figure 1 shows one example of many other installation methods for inclining or tilting the luminaire on the Cikampek and Cipularang freeways. The average illuminance, which does not follow the recommendation of the Indonesian National Standard (SNI), will make uniformity and visual performance impossible. According to SNI [10], which regulates the street lighting specification in urban areas that is still valid, the average illuminance value  $E_{av}$  for freeways is 15 - 20 Lux". Therefore, the road lighting quality in Cikampek and Cipularang toll needs to be improved, including the lighting level (to achieve average road-surface luminance), overall and longitudinal uniformity, surround ratio, and threshold increment [14]. Therefore, this research tries to suggest the most efficient installation method for road lighting freeways through optimization methods of Photometric Quantities using the SNI 7391:2008.

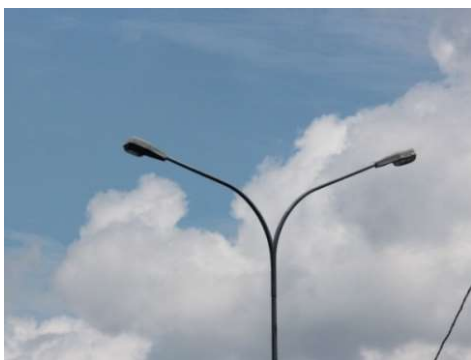

Figure 1: Different tilting of the luminaire on Cikampek and Cipularang toll road

### 3. RESEARCH DESIGN

The simulations were conducted in Dialux Evo 7.1 software. The simulation objective was to satisfy Indonesia National Standard (SNI) 7391:2008 regarding freeway, as mentioned in subchapter 2, paragraph 2. There are five parameters in SNI: average illumination ( $E_{avg}$ ), uniformity calculated by dividing minimum illuminance with maximum illuminance ( $g1$ ), average luminance ( $L_{avg}$ ), uniformity calculated by dividing minimum luminance with maximum luminance (VD), uniformity calculated by dividing minimum luminance with average luminance (VI), and glare threshold (TJ). In the international standard, VD is a  $U1$  (longitudinal uniformity), and VI is an  $Uo$  (overall uniformity), which is shown in Table 1 [15].

The Cikampek and Cipularang toll road was simulated as three traffic lanes, each with a 3.5 m width, 1 m of inner shoulder inside, and 2 m of outer shoulder outside, so the total road width was 13.5 m, as shown in Figure 2.

The toll road consists of 2 directions from Jakarta to Bandung and the opposite. Both directions are separated by road medians. The reflectance value for the simulation based on CIE 2001 in [15, 17], road-surface class limits of the R classification system with the standard  $Qo$  value for each class for asphalt is R3 class was 0.07. The surface of the hardened paved with dark aggregate and light reflection models that tend to be specular. Most major streets in Cikampek and Cipularang toll roads have a road surface made of asphalt.

Road-lighting design principally involves planning to illuminate the road surface area ahead so it can be surveyed as efficiently as possible [15]. Eight variables are used for the simulation road-lighting design: lighting arrangements, type of lamp, pole distance or spacing, mounting height, inclining or tilting the luminaire, overhang, boom length, and maintenance factor (Figure 3 and Table 2). There are five basic lighting arrangements: single-sided, staggered, opposite, central, and twin central [15]. The lighting arrangements on the Cikampek and Cipularang toll road is single-sided, but it is not recommended [15, 17]. Therefore, in the simulation, three lighting arrangements were used: the central, the staggered, and the opposite, as shown in Figure 4. The type of lamp used in the simulation was limited to two luminaires of LED BRP372 LED159NW DM MP1 and BRP372 LED159NW DM MP1. The specification and polar luminous intensity diagram of both LED luminaires are given in Figure 5.



Table 1: Part of the SNI 7391:2008 Regarding Toll Road Lighting

Type of Road	Illuminance		Luminance			Glare
	E <sub>avg</sub> (lux)	Uniformity	L <sub>avg</sub> (cd/m <sup>2</sup> )	Uniformity		
		g <sub>1</sub>		VD	VI	TJ (%)
Toll road	15-20	0.14-0.20	1.5	0.40	0.50-0.70	10-20

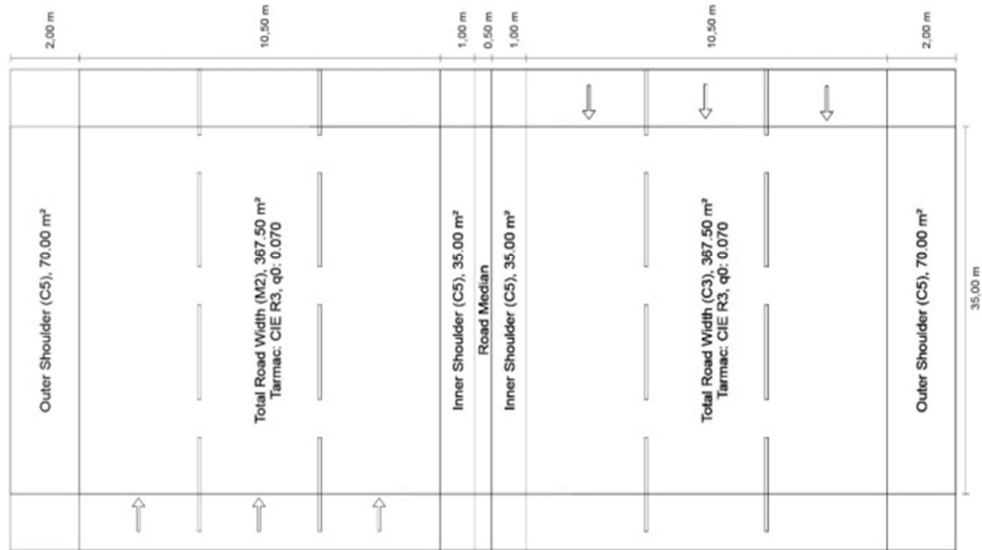

Figure 2: Preview of the Cikampek and Cipularang toll road

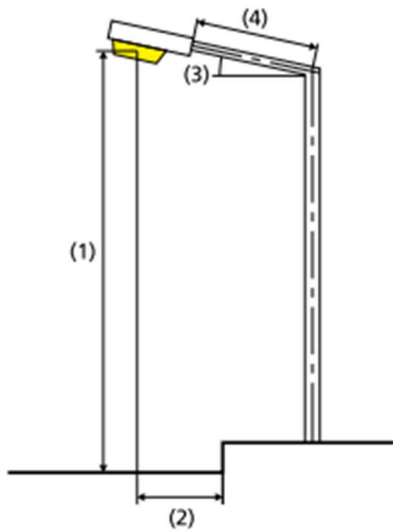
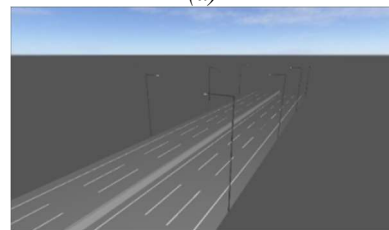

Figure 3: Lighting installation for the (1) Mounting height, (2) Overhang, (3) Inclining or tilting the luminaire, and (4) Boom Length



(a)



(b)

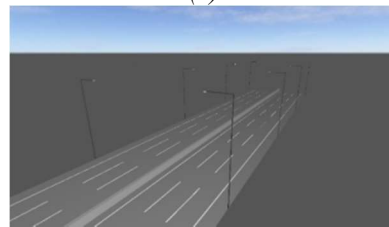

(c)

Figure 4: The Lighting Arrangements (a) Central (b) Staggered (c) Opposite

Light output ratio: 99.99%  
Lamp luminous flux: 13100 lm  
Luminaire luminous flux: 13098 lm  
Power: 120.0 W  
Luminous efficacy: 109.2 lm/W

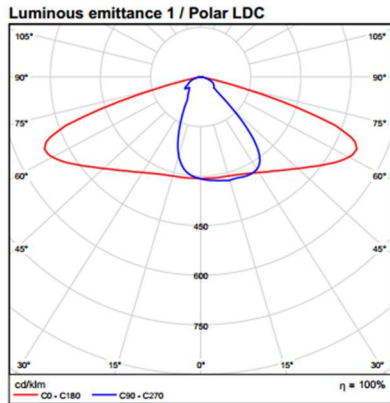

(a)

Light output ratio: 99.99%  
Lamp luminous flux: 15900 lm  
Luminaire luminous flux: 15898 lm  
Power: 151.6 W  
Luminous efficacy: 104.9 lm/W

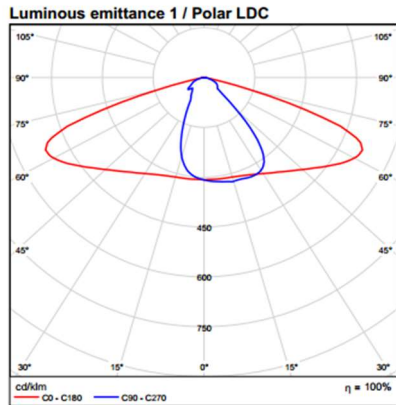

(b)

(a) BRP372 LED131NW DM MP1 and  
(b) BRP372 LED159NW DM MP1

Figure 5: Specification and Polar Diagram of the LED Luminaires

Table 2: Seven variables of the road-lighting design for the simulation

Seven Variable	
Lighting arrangements	The central, the staggered, and the opposite
Mounting height (m)	11 m; 13 m; and 15 m
Light overhang (m)	0.5 m; 1 m; and 1.5 m
Inclining or tilting the luminaire (degree)	0°, 5°, and 10°
Spacing (m)	30 m and 35 m
Type of LED luminaire	BRP372 LED131NW DM MP1 and BRP372 LED159NW DM MP1
Boom length	2.5 m; 3 m; 3.5 m
Maintenance Factor	0.7 [18]

#### 4. SIMULATION RESULTS

Based on the combination of 7 variables used for the road-lighting design in the simulation, 324 scenarios were obtained. The simulation of the data is visualized using a scattered graph. The graph consists of lighting arrangements, the central, the staggered, and the opposite. Therefore, every graph consists of 108 scenarios. Figure 6 shows the central lighting arrangements; Figure 7 visualizes the staggered lighting arrangements, and Figure 8 shows the opposite. The chosen parameter to plot the graph was  $E_{avg}$  with  $g1$  and  $L_{avg}$  with  $VD$ . These parameters were chosen because  $E_{avg}$  was the most satisfying data and  $L_{avg}$  was the minor satisfying data, while  $g1$  and  $VD$  were the uniformity for  $E_{avg}$  and  $L_{avg}$ , respectively. The blue dots showed all the probabilities, and the red dots represented the combination that satisfied the Indonesia National Standard (SNI). The green line indicates the minimum value from the SNI 7391:2008.

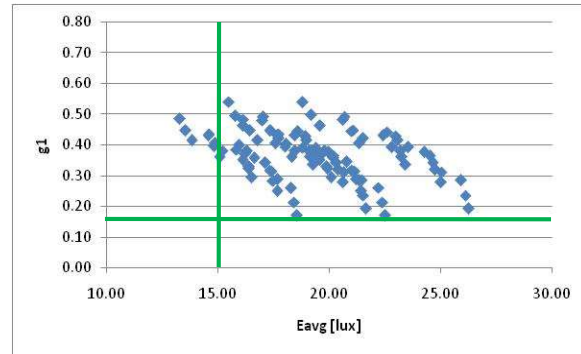

(a)

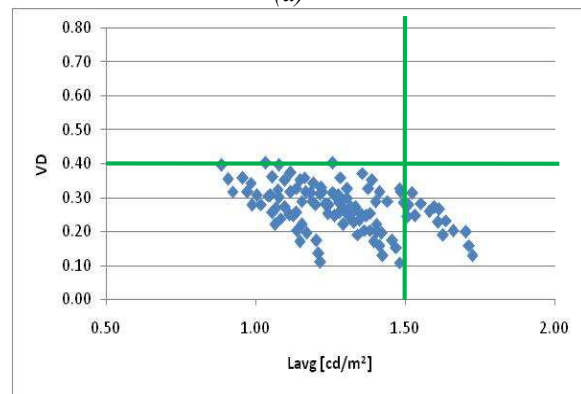

(b)

(a)  $E_{avg}$  vs  $g1$ ; (b)  $L_{avg}$  vs  $VD$   
Figure 6: Result of Simulation for the Central Lighting Arrangements

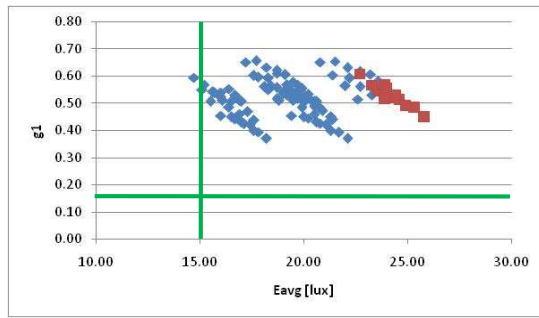

(a)

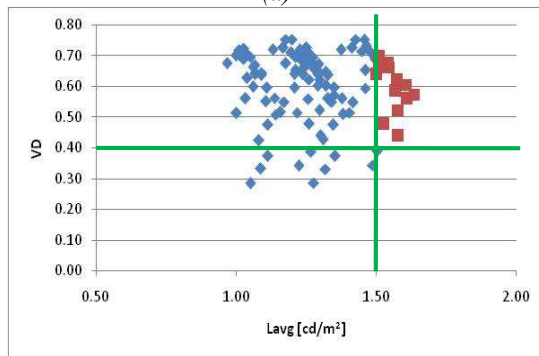

(b)

(a)  $E_{avg}$  vs  $gI$ ; (b)  $L_{avg}$  vs  $VD$

Figure 7: Result of Simulation for the Staggered Lighting Arrangements

The graphs above show that the most critical metrics were  $L_{avg}$  and  $VD$  because if these metrics could be satisfied, the other metrics would also be satisfied. Also, it could be seen that the central lighting arrangements method did not give a single combination that could fulfil the national standard. The staggered and opposite lighting arrangements give 14 and 15 out of 108 combinations that fulfilled the national standard. The summary of the satisfying combinations is shown in Tables 3 and 4.

From the result above, the luminaire type that could meet the national standard was only BRP372 LED159NW DM MP1 which had 150W and spacing was 30 meters, while other variables varied. It also could be seen that 11 meters of height resulted in the most satisfying combinations, with 15 out of 29 combinations.

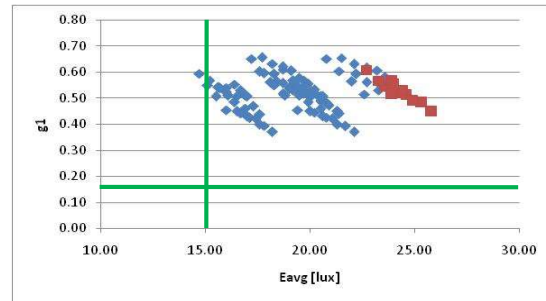

(a)

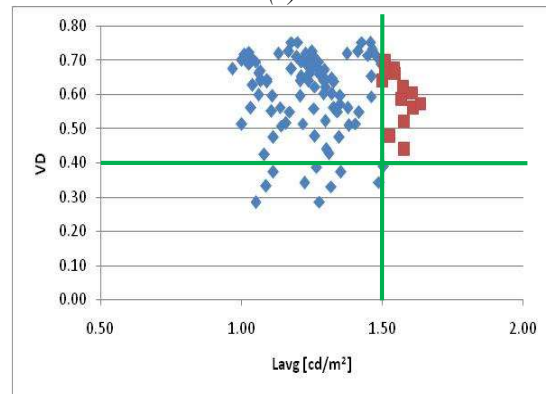

(b)

(a)  $E_{avg}$  vs  $gI$ ; (b)  $L_{avg}$  vs  $VD$

Figure 8: Result of Simulation for the Opposite Lighting Arrangements

Table 3: Combination Satisfied the SNI 7391:2008 with the staggered lighting arrangements

LED Luminaire	Spac. (m)	M.Height (m)	Incl (°)	Overhang (m)	E <sub>avg</sub> [lux]	g1	L <sub>avg</sub> [cd/m <sup>2</sup> ]	VD	VI	TJ [%]
BRP372 LED159NW DM MP1	30	11	0	1.5	24.00	0.52	1.58	0.44	0.64	8
BRP372 LED159NW DM MP1	30	11	5	1.5	24.90	0.49	1.61	0.56	0.77	8
BRP372 LED159NW DM MP1	30	11	5	1.0	24.30	0.52	1.58	0.52	0.73	8
BRP372 LED159NW DM MP1	30	11	5	0.5	23.60	0.54	1.53	0.48	0.69	8
BRP372 LED159NW DM MP1	30	11	10	1.5	25.80	0.45	1.64	0.57	0.75	9
BRP372 LED159NW DM MP1	30	11	10	1.0	25.30	0.49	1.61	0.60	0.80	9
BRP372 LED159NW DM MP1	30	11	10	0.5	24.60	0.51	1.57	0.59	0.79	9
BRP372 LED159NW DM MP1	30	13	0	1.5	22.70	0.61	1.50	0.64	0.82	7
BRP372 LED159NW DM MP1	30	13	5	1.5	23.90	0.52	1.55	0.66	0.81	7
BRP372 LED159NW DM MP1	30	13	5	1.0	23.30	0.57	1.51	0.67	0.85	7
BRP372 LED159NW DM MP1	30	13	10	1.5	24.90	0.49	1.57	0.62	0.75	8
BRP372 LED159NW DM MP1	30	13	10	1.0	24.40	0.53	1.54	0.68	0.82	8
BRP372 LED159NW DM MP1	30	13	10	0.5	23.90	0.57	1.51	0.70	0.86	7
BRP372 LED159NW DM MP1	30	15	10	1.5	24.00	0.55	1.51	0.66	0.75	7

Table 4: Combination Satisfied the SNI 7391:2008 with the Opposite Lighting Arrangements

LED Luminaire	Spac. (m)	M.Height (m)	Incl (°)	Overhang (m)	E <sub>avg</sub> [lux]	g1	L <sub>avg</sub> [cd/m <sup>2</sup> ]	VD	VI	TJ [%]
BRP372 LED159NW DM MP1	30	15	10	1.5	24.02	0.57	1.51	0.65	0.74	6
BRP372 LED159NW DM MP1	30	13	0	1.5	22.71	0.61	1.50	0.65	0.82	6
BRP372 LED159NW DM MP1	30	13	5	1.5	23.94	0.54	1.55	0.66	0.80	6
BRP372 LED159NW DM MP1	30	13	5	1.0	23.35	0.58	1.51	0.68	0.84	6
BRP372 LED159NW DM MP1	30	13	10	1.5	24.94	0.50	1.57	0.61	0.73	6
BRP372 LED159NW DM MP1	30	13	10	1.0	24.44	0.55	1.54	0.67	0.80	6
BRP372 LED159NW DM MP1	30	13	10	0.5	23.88	0.58	1.51	0.70	0.85	7
BRP372 LED159NW DM MP1	30	11	0	1.5	24.00	0.53	1.58	0.48	0.69	8
BRP372 LED159NW DM MP1	30	11	0	1.0	23.36	0.55	1.54	0.42	0.63	8
BRP372 LED159NW DM MP1	30	11	5	1.5	24.90	0.51	1.62	0.59	0.79	8
BRP372 LED159NW DM MP1	30	11	5	1.0	24.27	0.54	1.58	0.56	0.77	8
BRP372 LED159NW DM MP1	30	11	5	0.5	23.59	0.56	1.53	0.51	0.73	8
BRP372 LED159NW DM MP1	30	11	10	1.5	25.82	0.46	1.64	0.57	0.73	8
BRP372 LED159NW DM MP1	30	11	10	1.0	25.26	0.50	1.61	0.62	0.81	8
BRP372 LED159NW DM MP1	30	11	10	0.5	24.62	0.54	1.57	0.61	0.81	8

Table 5: Top ten most optimum results

Arr	Dist (m)	Height (m)	Incl (°)	Overhang (m)	Lavg [cd/m <sup>2</sup> ]	VD	F
OPP	30	13	10	0.5	1.51	0.70	1.71
STG	30	13	10	1.0	1.54	0.68	1.71
TS	30	13	10	0.5	1.51	0.70	1.71
OPP	30	13	10	1.0	1.54	0.67	1.70
STG	30	13	5	1.5	1.55	0.66	1.69
OPP	30	13	5	1.5	1.55	0.66	1.69
OPP	30	11	10	1.0	1.61	0.62	1.69
OPP	30	13	5	1.0	1.51	0.68	1.69
STG	30	13	5	1.0	1.51	0.67	1.68
STG	30	11	10	1.0	1.61	0.60	1.67

OPP=the opposite, and STG = the staggered

Table 6: The Most Optimum Result of Simulation

Luminaire	L.Arr	Spac. (m)	M.Heigt (m)	Incl (°)	Overhang (m)	E <sub>avg</sub> [lux]	g1	L <sub>avg</sub> [cd/m <sup>2</sup> ]	VD	VI	TJ [%]
BRP372 LED159NW	OPP	30	13	10	0.5	23.88	0.58	1.51	0.70	0.85	7
BRP372 LED159NW	STG	30	13	10	1.0	24.40	0.53	1.54	0.68	0.82	8
BRP372 LED159NW	STG	30	13	10	0.5	23.90	0.57	1.51	0.70	0.86	7

An objective function was introduced to choose the most optimum combination; since  $L_{avg}$  and VD are the most crucial metrics, the objective function should consist of these two metrics with the assumption that these two metrics were weighted the same. VD is unitless metrics, then  $L_{avg}$  should be converted to unitless metrics. This metric was divided by  $1.5 \text{ cd/m}^2$  to attain the unitless  $L_{avg}$ , as  $1.5 \text{ cd/m}^2$  was the minimum average luminance value in SNI 7391:2008. The objective function could be written as:

$$F = \frac{L_{avg}}{1.5 \text{ cd/m}^2} + VD \quad (1)$$

From the top ten (Table 5), 80% of the most optimum solution was 13 meters mounting height though the 11 meters height was dominant in satisfying the SNI 7391:2008. The inclination should be  $5^\circ$  or  $10^\circ$ ; the overhang could be all inputs. The optimum result is produced in three combinations with an F value of 1.71. The summary of the result is shown in Table 6.

## 5. CONCLUSIONS

Based on the simulation results using Dialux, the Cikampek and Cipularang toll roads must be reconfigured with the following lighting components: staggered and opposite lighting arrangements with 30 meters spacing to match the SNI 7391:2008. The mounting height should be 13

meters with an inclining or tilt angle of 10 degrees and an overhang of 0.5 meters or 1.5 meters. By using the configuration above, these combinations will result in average illuminance between 23.88 lux and 24.40 lux, with minimum uniformity of 0.53. The minimum value for average luminance is  $1.51 \text{ cd/m}^2$  with a uniformity of 0.70.

The result also shows that the average illuminance ( $E_{avg}$ ) can be fulfilled by almost all combinations possible. On the contrary, only a few fulfil the average luminance ( $L_{avg}$ ). By increasing the average illuminance and average luminance, it is hoped that the risk of accidents for motorists on the toll road can be minimized. Furthermore, other results show that condition yields an insight that to meet the Indonesia National Standard, the metrics that need attention are  $L_{avg}$  and its uniformity, VD (dividing minimum luminance with maximum luminance).

## 6. ACKNOWLEDGEMENT

Thanks to the Ministry of Education and Culture for the research funding of the doctoral program. Additional thanks to PT Jasa Marga, Tbk, Purbaleunyi branch, who has provided the secondary data on the Cipularang freeway, which is very useful in this research.

## REFERENCES:

- [1] Media Harian Kompas, Traffic Accident, Driver Factor as The Dominant Cause Jakarta (17 April 2015).
- [2] Jusuf, A., Nurprasetio, I.P. & Prihutama, A., *Macro Data Analysis of Traffic Accidents in Indonesia*, Journal of Engineering and Technological Sciences, 49 (1), 2017, pp. 132-143.
- [3] Santosa, S.P., Mahyuddin, A.I. & Sunoto, F.B., *Anatomy of Injury Severity and Fatality in Indonesia Traffic Accident*, Journal of Engineering and Technological Sciences, 49 (3), 2017, pp. 412-422.
- [4] PT JasaMargaTbk, Purbaleunyi branch, Summary of Toll Road Accident Data of Dawuan – Padalarang 2011 to 2015, 2016.
- [5] Setyaningsih, E., Putranto, L.S., Soegijanto, Soelami, F.X.N., Analysis of the visual safety perception and the clarity of traffic signs and road markings in the presence of road lighting in straight and curved road, MATEC Web Conf., Vol 181, 2018, article number 04001.
- [6] Tetri, E., Chenani, S.B., SamuliRasanen, R., Baumgartner H., et al., *Tutorial: Road Lighting for Efficient and Safe Traffic Environments*, Leukos, Vol. 13, 2017, pp. 223 – 241.
- [7] Li, F., Chen, Y., Liu, Y., and Chen, D., *Comparative in Situ of LEDs and HPS in Road Lighting*, Leukos 8 (3), 2012, pp. 205 – 214.
- [8] Setyaningsih, E., Fat, J., Zureidar, I., and Wardhani, L., *Performance of LED Lights Installed on DKI Jakarta Streets*, The 7<sup>th</sup> Electrical Power Electronics, Controls, Communications, Informatics Seminar (EECCIS), Brawijaya University, Malang, 2014.
- [9] Armanto, R., Soelami, N., and Soegijanto, *Evaluation on Lighting Condition and Visual Legibility of Road Surface and Traffic sign in Bandung City*. Proceeding of the 9<sup>th</sup> SENVAR/2<sup>nd</sup> ISESEE, Syah Alam, Malaysia, 2008.
- [10] National Standardization Agency of Indonesia, *Urban Road Lighting Specification*. SNI 7391:2008.
- [11] Ministry of Public Works. Guideline of Intercity Road Geometric Plan, Directorate-General of Highways, Indonesia, 1997.
- [12] Law of the Republic of Indonesia No 22/2009, On Road Traffic and Transportation, Ministry of Transportation, Jakarta.
- [13] Ministry of Public Works, 2011, Road Technical Requirement and Road Technical Design, No. 19, 2011.
- [14] Sędziwy, A., *A New Approach to Street Lighting Design*, Leukos 12, pp 151-162, 2016.
- [15] Van Bommel, W., Road Lighting, Fundamentals, Technology and Application, Springer International Publishing, Switzerland, 2015.
- [16] Setyaningsih, E, Putranto, L.S., Soegijanto, and Soelami, F.X.N., *The Visual Perception of The Car Drivers Dealing with The Road Supporting Facilities, Road Median, Potholes, and Other Cars on a Freeways with and Without Lighting*, Journal of Physics: Conference Series 1114 (1), 012125, 2018.
- [17] ANSI/IES RP-8-00, Roadway Lighting ANSI Approved, 2005.
- [18] Royer M., LLD & LED: *Choosing the Right Light Loss Factor for LED Street Lighting*. IES Street and Area Lighting Conference, Nashville, 2014.

# OPTIMIZATION OF PHOTOMETRIC QUANTITIES FOR ROAD LIGHTING FREEWAYS IN INDONESIA

*by Endah Setyaningsih*

---

**Submission date:** 12-Apr-2023 08:02AM (UTC+0700)

**Submission ID:** 2062062542

**File name:** 32Vol101No6\_1.pdf (1.47M)

**Word count:** 4450

**Character count:** 21754

## OPTIMIZATION OF PHOTOMETRIC QUANTITIES FOR ROAD LIGHTING FREEWAYS IN INDONESIA

ENDAH SETYANINGSIH<sup>1</sup>, HENRY CANDRA<sup>2</sup>

<sup>1</sup>Universitas Tarumanagara, Faculty of Engineering, Department of Electrical Engineering, Indonesia

<sup>2</sup>Universitas Trisakti, Faculty of Industrial Technology, Department of Electrical Engineering, Indonesia

E-mail: <sup>1</sup>endahs@ft.untar.ac.id, <sup>2</sup>henrycandra@trisakti.ac.id

### ABSTRACT

Road lighting is one factor affecting driving safety on the road. Inadequate lighting has the potential to cause a traffic accident based on our previous research. Moreover, many traffic accidents occur between 18.00 - 24.00 and 00.00 - 06.00, even though the traffic volume has decreased at night. In order to investigate further the case mentioned above, this paper discussed the research for the lighting system on Cikampek and Cipularang toll roads as a sample uses case. The results revealed that the lighting system in Cikampek and Cipularang toll roads does not comply with the Indonesian national standard for lighting. In addition, a Dialux software simulation was conducted to determine the most optimum photometric illuminance, including average luminance and uniformity for the road lighting in Cikampek and Cipularang toll roads. The simulation implemented seven variables of the road-lighting design, resulting in 324 scenarios giving average illuminance between 23.88 lux to 24.40 lux with minimum uniformity of 0.53 and average luminance is 1.51 cd/m<sup>2</sup> with a uniformity of 0.70. The simulation results show that if the Cikampek and Cipularang toll roads are redesigned according to the simulation results, they will be following SNI 7391: 2008 and able to reduce the risk of accidents.

**Keywords:** *Illuminance, Luminance, Road Lighting, Photometric, Uniformity*

### 1. INTRODUCTION

The number of traffic accidents in Indonesia is still very high. The data from the National Traffic Police Corps of Indonesia (Korlantas Polri) shows that there were 100,106 cases of accidents, with 26,416 deaths in 2013. On average, there were 11 cases, with three people dying every hour [1]. Jusuf [2] mentions that road accidents are a severe problem in Indonesia. In 2014, the police reported approximately 28,000 fatalities due to accidents on the streets and roadways of Indonesia. The fatality rate from traffic accidents per 100,000 population was about 12. This fatality rate is very high compared to neighbouring countries like Singapore (4.8) and Australia (5.2).

Traffic accidents should be given more attention in the transportation area. Some of the factors that become the cause of traffic accidents are motorcycles (Suthanaya in Jusuf et al. [2]), and underlying traffic violation behaviours and types of traffic violations committed by young motorcyclists on urban roads in Indonesia (Joewono et al. in Jusuf et al. [2]).

Santosa et al. [3] show that the traffic accidents in Indonesia between 2010 and 2014 were dominated by motorcycles, contributing to more than 70% of road traffic accidents. Road traffic accidents involving passenger cars and trucks contributed approximately 12% and 10%, respectively. Road traffic accidents involving buses and special vehicles such as three-wheelers accounted for 5% and 1%, respectively.

According to the data from PT. Jasa Marga Tbk. Purbaleunyi branch about the traffic accident on Cipularang freeways from 2013 to 2015, the type of vehicle that caused the most accidents are 'minibus,' among the four factors causing traffic accident is human factors, vehicle factors, road factors, and environmental factors. The most cause of traffic accidents is human factors [4]. Santosa et al. [3] state that most traffic accidents in Indonesia are caused by human factors (88%), and vehicle factors in traffic accidents amounted to 3%. Road and environmental factors that caused traffic accidents amounted to 8% and were mainly due to road damage and potholes, slippery roads, sharp turns, and inadequate lighting. However, this paper does not include the data to support their statement



about inadequate lighting. Furthermore, according to the driver's perception, visibility to see traffic signs, the colour of traffic signs, potholes, road medians, sign symbols, and texts is inadequate due to insufficient lighting. [5].

So inadequate road lighting causes traffic accidents. According to Santosa et al. [3], most traffic accidents occur during the daytime/working hours; 30% of accidents occur between 06.00 and 12.00, and 32% occur between 12.00 and 18.00. Most accidents occurred during rush hours when most people were on their way to work in the morning and home in the afternoon. High traffic density and congestion during these hours add to the traffic accident potential. Interestingly, the traffic accident frequency remained significantly high (23,000-24,000) from 18.00 to 24.00. This high frequency of traffic accidents coincided with a high traffic volume of people who elected to avoid the afternoon rush hour.

However, traffic accident also occurs between 00.00 to 06.00 [3]. Therefore, during the nighttime, about 38.5% of traffic accident happens. In that period, the traffic volume decreased compared to other periods. The situation also takes place on the Cipularang freeways [4]. It can be deduced that traffic accidents that occur from human factors are caused by poor visibility, which is affected by inadequate road lighting that creates eye fatigue and drowsiness. The data that support this matter cannot be obtained in Indonesia [11] therefore, further study is required to investigate the effect of road lighting on traffic accidents in Indonesia.

Especially for road lighting, according to (Tetri et al. [6]), road lighting is undeniably crucial for users to observe obstacles, anticipate ahead, and avoid accidents. Road lighting reduces the number of an accident on average by 30%. While according to (Li [7]) good lighting is needed to estimate the car's speed, monitor dangerous conditions from the side, and keep a distance from other vehicles. Several studies have been conducted in Jakarta and Bandung, and the results indicate the presence of uneven illuminance on the road surface and less or excessive illumination according to the road lighting standards National Standard of Indonesia SNI 7391:2008 [8,9,10].

Inadequate road lighting is caused by low average illuminance and average luminance. Therefore, this research focuses on finding the appropriate lighting component settings to obtain sufficient average illuminance and average luminance required on toll roads to reduce the risk of

accidents. The research was realized by conducting a simulation using Dialux by taking a case study on the Cikampek and Cipularang toll roads.

## 2. CIPULARANG FREEWAYS AND NATIONAL STANDARD OF INDONESIA

The research was conducted on Cikampek and Cipularang freeways. The Cikampek freeway connects the Jakarta freeway to Cikampek, from the Cawang to the Cikampek interchange. At the same time, the Cipularang freeway connects Cikampek to Padalarang freeway from the interchanges of Dawuan to Padalarang. Some of these freeways are part of the Purbaleunyi freeway (Purwakarta-Bandung Cileunyi). The freeways have geometric road elements, including uphill, downhill, straight, and curved ones. A road with such complex geometric elements must consider the visibility of the road users that meet the safety standards [11].

In addition, the Cikampek and Cipularang freeways should have street lightings that meet the law of the Republic of Indonesia [12]. The toll roads have many 'areas with limited visibility. Therefore, the roads should have street lightings that follow the regulation of the Ministry of Public Works and Housing of the Republic of Indonesia [13]. The National Standard of Indonesia for road lighting is still in effect because the SNI 7391: 2008 regulates urban lighting specifications. This standard is used as a reference in Indonesia's planning and application of street lighting.

Three groups of photometric quantities for international standard consists of (1) the luminance of the road surface of the carriageway for the dry surface condition, the overall uniformity of the luminance ( $U_0$ ), and the longitudinal uniformity of the luminance ( $U_l$ ), (2) Disability glare: the threshold increment (TI) and (3) Lighting of surroundings: surround ratio (SR) according to [14,15]. The visual comfort of car/motorcycle drivers is influenced by the parameters above, so by modifying these seven variables, visual comfort can be achieved. Those parameters are regulated in The National Standards of Indonesia (SNI) for toll road lighting, SNI 7391: 2008, which includes the photometric quantities such as average illuminance, average luminance, and glare, shown in Table 1 and is a standard that still applies.

Based on the above analysis, a simulation was carried out using Dialux software to obtain optimization of photometric quantities for road lighting freeways in Indonesia. The simulation using the Dialux software gives the following results, which are discussed in more detail below. The

existing lighting condition on Cikampek and Cipularang freeways has an average illuminance value ( $E_{avg}$ ) between 6 - 10 Lux [16]. The average illuminance value varied, caused by using different lamps and Correlated Color Temperature (CCT). Those are High-Pressure Sodium (HPS) with CCT reddish white and LED lamps with CCT bluish white and different wattage lights, different mounting heights, and different installations. Figure 1 shows one example of many other installation methods for inclining or tilting the luminaire on the Cikampek and Cipularang freeways. The average illuminance, which does not follow the recommendation of the Indonesian National Standard (SNI), will make uniformity and visual performance impossible. According to SNI [10], which regulates the street lighting specification in urban areas that is still valid, the average illuminance value  $E_{av}$  for freeways is 15 - 20 Lux". Therefore, the road lighting quality in Cikampek and Cipularang toll needs to be improved, including the lighting level (to achieve average road-surface luminance), overall and longitudinal uniformity, surround ratio, and threshold increment [14]. Therefore, this research tries to suggest the most efficient installation method for road lighting freeways through optimization methods of Photometric Quantities using the SNI 7391:2008.

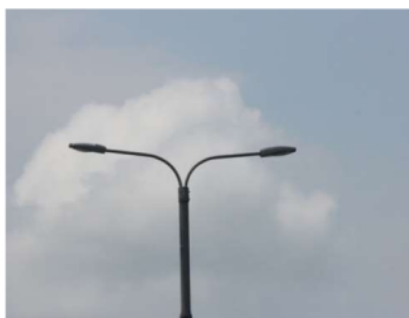

Figure 1: Different tilting of the luminaire on Cikampek and Cipularang toll road

### 3. RESEARCH DESIGN

The simulations were conducted in Dialux Evo 7.1 software. The simulation objective was to satisfy Indonesia National Standard (SNI) 7391:2008 regarding freeway, as mentioned in subchapter 2, paragraph 2. There are five parameters in SNI: average illumination ( $E_{avg}$ ), uniformity calculated by dividing minimum illuminance with maximum illuminance ( $g1$ ), average luminance ( $L_{avg}$ ), uniformity calculated by dividing minimum luminance with maximum luminance ( $VD$ ), uniformity calculated by dividing minimum luminance with average luminance ( $VI$ ), and glare threshold ( $TJ$ ). In the international standard,  $VD$  is a  $U1$  (longitudinal uniformity), and  $VI$  is an  $Uo$  (overall uniformity), which is shown in Table 1 [15].

The Cikampek and Cipularang toll road was simulated as three traffic lanes, each with a 3.5 m width, 1 m of inner shoulder inside, and 2 m of outer shoulder outside, so the total road width was 13.5 m, as shown in Figure 2.

The toll road consists of 2 directions from Jakarta to Bandung and the opposite. Both directions are separated by road medians. The reflectance value of the simulation based on CIE 2001 in [15, 17], road-surface class limits of the R classification system with the standard  $Qo$  value for each class for asphalt is R3 class was 0.07. The surface of the hardened paved with dark aggregate and light reflection models that tend to be specular. Most major streets in Cikampek and Cipularang toll roads have a road surface made of asphalt.

Road-lighting design principally involves planning to illuminate the road surface area ahead so it can be surveyed as efficiently as possible [15]. Eight variables are used for the simulation road-lighting design: lighting arrangements, type of lamp, pole distance or spacing, mounting height, inclining or tilting the luminaire, overhang, boom length, and maintenance factor (Figure 3 and Table 2). There are five basic lighting arrangements: single-sided, staggered, opposite, central, and twin central [15]. The lighting arrangements on the Cikampek and Cipularang toll road is single-sided, but it is not recommended [15, 17]. Therefore, in the simulation, three lighting arrangements were used: the central, the staggered, and the opposite, as shown in Figure 4. The type of lamp used in the simulation was limited to two luminaires of LED BRP372 LED159NW DM MP1 and BRP372 LED159NW DM MP1. The specification and polar luminous intensity diagram of both LED luminaires are given in Figure 5.

Table 1: Part of the SNI 7391:2008 Regarding Toll Road Lighting

Type of Road	Illuminance		Luminance			Glare TJ (%)
	E <sub>avg</sub> (lux)	Uniformity g1	L <sub>avg</sub> (cd/m <sup>2</sup> )	Uniformity		
				VD	VI	
Toll road	15-20	0.14-0.20	1.5	0.40	0.50-0.70	10-20

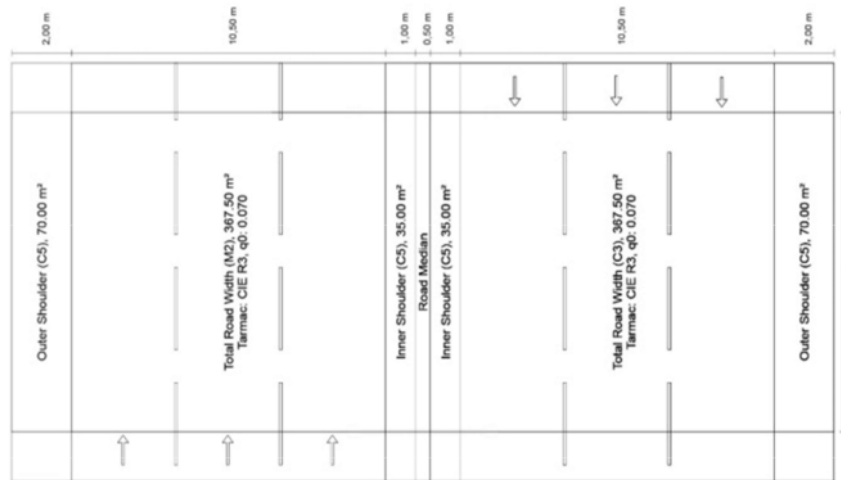

Figure 2: Preview of the Cikampek and Cipularang toll road

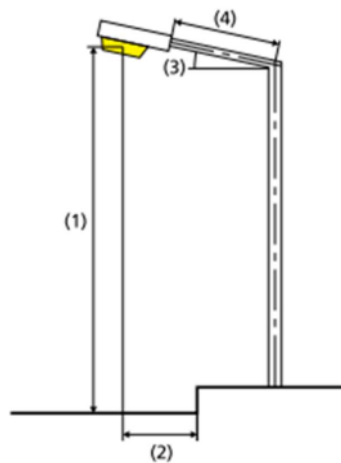

Figure 3: Lighting installation for the (1) Mounting height, (2) Overhang, (3) Inclining or tilting the luminaire, and (4) Boom Length

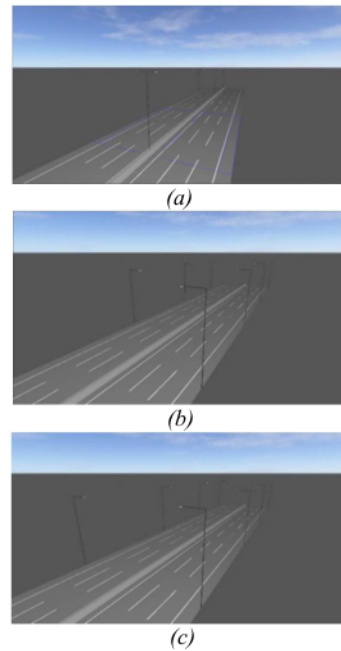
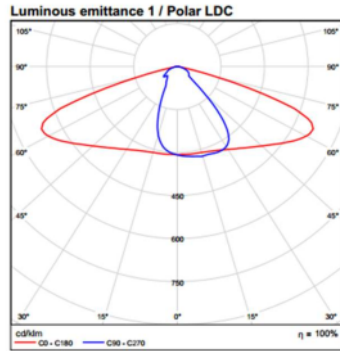

Figure 4: The Lighting Arrangements (a) Central (b) Staggered (c) Opposite

Light output ratio: 99.99%  
Lamp luminous flux: 13100 lm  
Luminaire luminous flux: 13098 lm  
Power: 120.0 W  
Luminous efficacy: 109.2 lm/W



(a)

Light output ratio: 99.99%  
Lamp luminous flux: 15900 lm  
Luminaire luminous flux: 15898 lm  
Power: 151.6 W  
Luminous efficacy: 104.9 lm/W

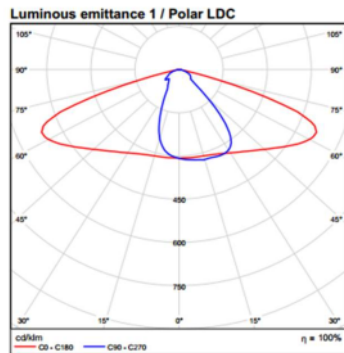

(b)

(a) BRP372 LED131NW DM MP1 and

(b) BRP372 LED159NW DM MP1

Figure 5: Specification and Polar Diagram of the LED Luminaires

Table 2: Seven variables of the road-lighting design for the simulation

Seven Variable	
Lighting arrangements	The central, the staggered, and the opposite
Mounting height (m)	11 m; 13 m; and 15 m
Light overhang (m)	0.5 m; 1 m; and 1.5 m
Inclining or tilting the luminaire (degree)	0°, 5°, and 10°
Spacing (m)	30 m and 35 m
Type of LED luminaire	BRP372 LED131NW DM MP1 and BRP372 LED159NW DM MP1
Boom length	2.5 m; 3 m; 3.5 m
Maintenance Factor	0.7 [18]

#### 4. SIMULATION RESULTS

Based on the combination of 7 variables used for the road-lighting design in the simulation, 324 scenarios were obtained. The simulation of the data is visualized using a scattered graph. The graph consists of lighting arrangements, the central, the staggered, and the opposite. Therefore, every graph consists of 108 scenarios. Figure 6 shows the central lighting arrangements; Figure 7 visualizes the staggered lighting arrangements, and Figure 8 shows the opposite. The chosen parameter to plot the graph was  $E_{avg}$  with  $g1$  and  $L_{avg}$  with  $VD$ . These parameters were chosen because  $E_{avg}$  was the most satisfying data and  $L_{avg}$  was the minor satisfying data, while  $g1$  and  $VD$  were the uniformity for  $E_{avg}$  and  $L_{avg}$ , respectively. The blue dots showed all the probabilities, and the red dots represented the combination that satisfied the Indonesia National Standard (SNI). The green line indicates the minimum value from the SNI 7391:2008.

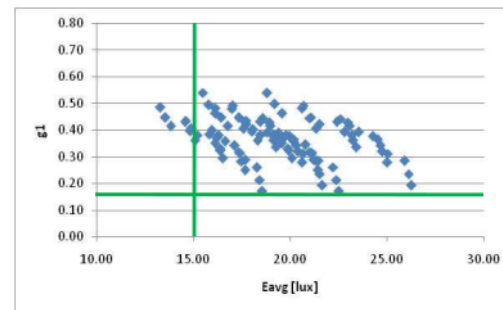

(a)

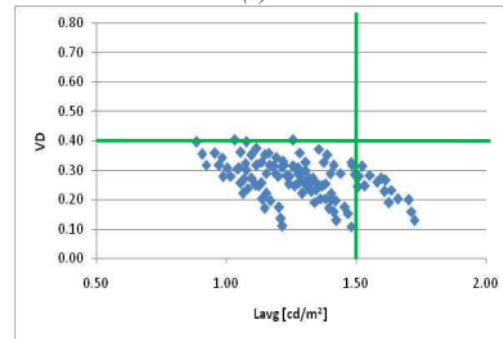

(b)

(a)  $E_{avg}$  vs  $g1$ ; (b)  $L_{avg}$  vs  $VD$

Figure 6: Result of Simulation for the Central Lighting Arrangements

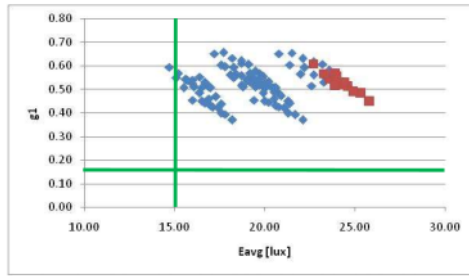

(a)

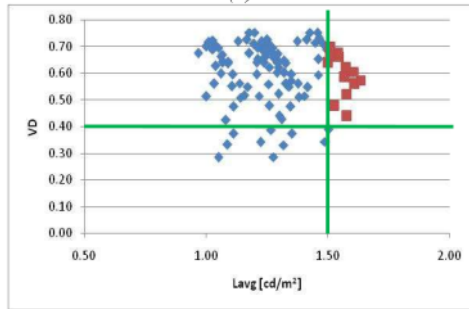

(b)

(a)  $E_{avg}$  vs  $gI$ ; (b)  $L_{avg}$  vs  $VD$

Figure 7: Result of Simulation for the Staggered Lighting Arrangements

The graphs above show that the most critical metrics were  $L_{avg}$  and  $VD$  because if these metrics could be satisfied, the other metrics would also be satisfied. Also, it could be seen that the central lighting arrangements method did not give a single combination that could fulfil the national standard. The staggered and opposite lighting arrangements give 14 and 15 out of 108 combinations that fulfilled the national standard. The summary of the satisfying combinations is shown in Tables 3 and 4.

From the result above, the luminaire type that could meet the national standard was only BRP372 LED159NW DM MP1 which had 150W and spacing was 30 meters, while other variables varied. It also could be seen that 11 meters of height resulted in the most satisfying combinations, with 15 out of 29 combinations.

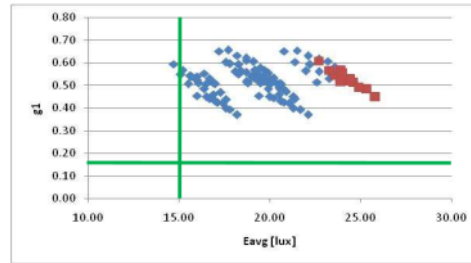

(a)

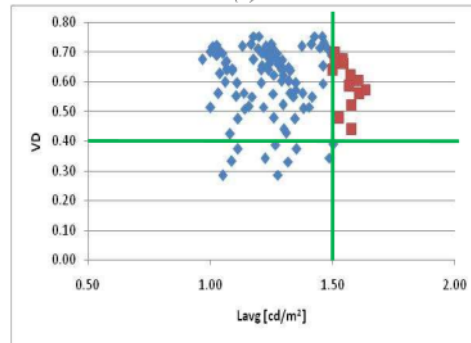

(b)

(a)  $E_{avg}$  vs  $gI$ ; (b)  $L_{avg}$  vs  $VD$

Figure 8: Result of Simulation for the Opposite Lighting Arrangements

Table 3: Combination Satisfied the SNI 7391:2008 with the staggered lighting arrangements

LED Luminaire	Spac. (m)	M.Height (m)	Incl (°)	Overhang (m)	E <sub>avg</sub> [lux]	gl	L <sub>avg</sub> [cd/m <sup>2</sup> ]	VD	VI	TJ [%]
BRP372 LED159NW DM MP1	30	11	0	1.5	24.00	0.52	1.58	0.44	0.64	8
BRP372 LED159NW DM MP1	30	11	5	1.5	24.90	0.49	1.61	0.56	0.77	8
BRP372 LED159NW DM MP1	30	11	5	1.0	24.30	0.52	1.58	0.52	0.73	8
BRP372 LED159NW DM MP1	30	11	5	0.5	23.60	0.54	1.53	0.48	0.69	8
BRP372 LED159NW DM MP1	30	11	10	1.5	25.80	0.45	1.64	0.57	0.75	9
BRP372 LED159NW DM MP1	30	11	10	1.0	25.30	0.49	1.61	0.60	0.80	9
BRP372 LED159NW DM MP1	30	11	10	0.5	24.60	0.51	1.57	0.59	0.79	9
BRP372 LED159NW DM MP1	30	13	0	1.5	22.70	0.61	1.50	0.64	0.82	7
BRP372 LED159NW DM MP1	30	13	5	1.5	23.90	0.52	1.55	0.66	0.81	7
BRP372 LED159NW DM MP1	30	13	5	1.0	23.30	0.57	1.51	0.67	0.85	7
BRP372 LED159NW DM MP1	30	13	10	1.5	24.90	0.49	1.57	0.62	0.75	8
BRP372 LED159NW DM MP1	30	13	10	1.0	24.40	0.53	1.54	0.68	0.82	8
BRP372 LED159NW DM MP1	30	13	10	0.5	23.90	0.57	1.51	0.70	0.86	7
BRP372 LED159NW DM MP1	30	15	10	1.5	24.00	0.55	1.51	0.66	0.75	7

Table 4: Combination Satisfied the SNI 7391:2008 with the Opposite Lighting Arrangements

LED Luminaire	Spac. (m)	M.Height (m)	Incl (°)	Overhang (m)	E <sub>avg</sub> [lux]	gl	L <sub>avg</sub> [cd/m <sup>2</sup> ]	VD	VI	TJ [%]
BRP372 LED159NW DM MP1	30	15	10	1.5	24.02	0.57	1.51	0.65	0.74	6
BRP372 LED159NW DM MP1	30	13	0	1.5	22.71	0.61	1.50	0.65	0.82	6
BRP372 LED159NW DM MP1	30	13	5	1.5	23.94	0.54	1.55	0.66	0.80	6
BRP372 LED159NW DM MP1	30	13	5	1.0	23.35	0.58	1.51	0.68	0.84	6
BRP372 LED159NW DM MP1	30	13	10	1.5	24.94	0.50	1.57	0.61	0.73	6
BRP372 LED159NW DM MP1	30	13	10	1.0	24.44	0.55	1.54	0.67	0.80	6
BRP372 LED159NW DM MP1	30	13	10	0.5	23.88	0.58	1.51	0.70	0.85	7
BRP372 LED159NW DM MP1	30	11	0	1.5	24.00	0.53	1.58	0.48	0.69	8
BRP372 LED159NW DM MP1	30	11	0	1.0	23.36	0.55	1.54	0.42	0.63	8
BRP372 LED159NW DM MP1	30	11	5	1.5	24.90	0.51	1.62	0.59	0.79	8
BRP372 LED159NW DM MP1	30	11	5	1.0	24.27	0.54	1.58	0.56	0.77	8
BRP372 LED159NW DM MP1	30	11	5	0.5	23.59	0.56	1.53	0.51	0.73	8
BRP372 LED159NW DM MP1	30	11	10	1.5	25.82	0.46	1.64	0.57	0.73	8
BRP372 LED159NW DM MP1	30	11	10	1.0	25.26	0.50	1.61	0.62	0.81	8
BRP372 LED159NW DM MP1	30	11	10	0.5	24.62	0.54	1.57	0.61	0.81	8

Table 5: Top ten most optimum results

Arr	Dist (m)	Height (m)	Incl (°)	Overhang (m)	Lavg [cd/m <sup>2</sup> ]	VD	F
OPP	30	13	10	0.5	1.51	0.70	1.71
STG	30	13	10	1.0	1.54	0.68	1.71
TS	30	13	10	0.5	1.51	0.70	1.71
OPP	30	13	10	1.0	1.54	0.67	1.70
STG	30	13	5	1.5	1.55	0.66	1.69
OPP	30	13	5	1.5	1.55	0.66	1.69
OPP	30	11	10	1.0	1.61	0.62	1.69
OPP	30	13	5	1.0	1.51	0.68	1.69
STG	30	13	5	1.0	1.51	0.67	1.68
STG	30	11	10	1.0	1.61	0.60	1.67

OPP=the opposite, and STG = the staggered

Table 6: The Most Optimum Result of Simulation

Luminaire	L.Arr	Spac. (m)	M.Heigt (m)	Incl (°)	Overhang (m)	E <sub>avg</sub> [lux]	g1	L <sub>avg</sub> [cd/m <sup>2</sup> ]	VD	VI	TJ [%]
BRP372 LED159NW	OPP	30	13	10	0.5	23.88	0.58	1.51	0.70	0.85	7
BRP372 LED159NW	STG	30	13	10	1.0	24.40	0.53	1.54	0.68	0.82	8
BRP372 LED159NW	STG	30	13	10	0.5	23.90	0.57	1.51	0.70	0.86	7

An objective function was introduced to choose the most optimum combination; since  $L_{avg}$  and VD are the most crucial metrics, the objective function should consist of these two metrics with the assumption that these two metrics were weighted the same. VD is unitless metrics, then  $L_{avg}$  should be converted to unitless metrics. This metric was divided by  $1.5 \text{ cd/m}^2$  to attain the unitless  $L_{avg}$ , as  $1.5 \text{ cd/m}^2$  was the minimum average luminance value in SNI 7391:2008. The objective function could be written as:

$$F = \frac{L_{avg}}{1.5 \text{ cd/m}^2} + VD \quad (1)$$

From the top ten (Table 5), 80% of the most optimum solution was 13 meters mounting height though the 11 meters height was dominant in satisfying the SNI 7391:2008. The inclination should be  $5^\circ$  or  $10^\circ$ ; the overhang could be all inputs. The optimum result is produced in three combinations with an F value of 1.71. The summary of the result is shown in Table 6.

## 5. CONCLUSIONS

Based on the simulation results using Dialux, the Cikampek and Cipularang toll roads must be reconfigured with the following lighting components: staggered and opposite lighting arrangements with 30 meters spacing to match the SNI 7391:2008. The mounting height should be 13

meters with an inclining or tilt angle of 10 degrees and an overhang of 0.5 meters or 1.5 meters. By using the configuration above, these combinations will result in average illuminance between 23.88 lux and 24.40 lux, with minimum uniformity of 0.53. The minimum value for average luminance is  $1.51 \text{ cd/m}^2$  with a uniformity of 0.70.

The result also shows that the average illuminance ( $E_{avg}$ ) can be fulfilled by almost all combinations possible. On the contrary, only a few fulfil the average luminance ( $L_{avg}$ ). By increasing the average illuminance and average luminance, it is hoped that the risk of accidents for motorists on the toll road can be minimized. Furthermore, other results show that condition yields an insight that to meet the Indonesia National Standard, the metrics that need attention are  $L_{avg}$  and its uniformity, VD (dividing minimum luminance with maximum luminance).

## 6. ACKNOWLEDGEMENT

Thanks to the Ministry of Education and Culture for the research funding of the doctoral program. Additional thanks to PT Jasa Marga, Tbk, Purbaleunyi branch, who has provided the secondary data on the Cipularang freeway, which is very useful in this research.

## REFERENCES:

- [1] Media Harian Kompas, Traffic Accident, Driver Factor as The Dominant Cause Jakarta (17 April 2015).
- [2] Jusuf, A., Nurprasetyo, I.P. & Prihutama, A., *Macro Data Analysis of Traffic Accidents in Indonesia*, Journal of Engineering and Technological Sciences, 49 (1), 2017, pp. 132-143.
- [3] Santosa, S.P., Mahyuddin, A.I. & Sunoto, F.B., *Anatomy of Injury Severity and Fatality in Indonesia Traffic Accident*, Journal of Engineering and Technological Sciences, 49 (3), 2017, pp. 412-422.
- [4] PT JasaMargaTbk, Purbaleunyi branch, Summary of Toll Road Accident Data of Dawuan – Padalarang 2011 to 2015, 2016.
- [5] Setyaningsih, E., Putranto, L.S., Soegijanto, Soelami, F.X.N., Analysis of the visual safety perception and the clarity of traffic signs and road markings in the presence of road lighting in straight and curved road, MATEC Web Conf., Vol 181, 2018, article number 04001.
- [6] Tetri, E., Chenani, S.B., SamuliRasanen, R., Baumgartner H., et al., *Tutorial: Road Lighting for Efficient and Safe Traffic Environments*, Leukos, Vol. 13, 2017, pp. 223 – 241.
- [7] Li, F., Chen, Y., Liu, Y., and Chen, D., *Comparative in Situ of LEDs and HPS in Road Lighting*, Leukos 8 (3), 2012, pp. 205 – 214.
- [8] Setyaningsih, E., Fat, J., Zureidar, I., and Wardhani, L., *Performance of LED Lights Installed on DKI Jakarta Streets*, The 7<sup>th</sup> Electrical Power Electronics, Controls, Communications, Informatics Seminar (EECCIS), Brawijaya University, Malang, 2014.
- [9] Armanto, R., Soelami, N., and Soegijanto, *Evaluation on Lighting Condition and Visual Legibility of Road Surface and Traffic sign in Bandung City*. Proceeding of the 9<sup>th</sup> SENVAR/2<sup>nd</sup> ISESEE, Syah Alam, Malaysia, 2008.
- [10] National Standardization Agency of Indonesia, *Urban Road Lighting Specification*. SNI 7391:2008.
- [11] Ministry of Public Works. Guideline of Intercity Road Geometric Plan, Directorate-General of Highways, Indonesia, 1997.
- [12] Law of the Republic of Indonesia No 22/2009, On Road Traffic and Transportation, Ministry of Transportation, Jakarta.
- [13] Ministry of Public Works, 2011, Road Technical Requirement and Road Technical Design, No. 19, 2011.
- [14] Sędziwy, A., *A New Approach to Street Lighting Design*, Leukos 12, pp 151-162, 2016.
- [15] Van Bommel, W., *Road Lighting, Fundamentals, Technology and Application*, Springer International Publishing, Switzerland, 2015.
- [16] Setyaningsih, E, Putranto, L.S., Soegijanto, and Soelami, F.X.N., *The Visual Perception of The Car Drivers Dealing with The Road Supporting Facilities, Road Median, Potholes, and Other Cars on a Freeways with and Without Lighting*, Journal of Physics: Conference Series 1114 (1), 012125, 2018.
- [17] ANSI/IES RP-8-00, Roadway Lighting ANSI Approved, 2005.
- [18] Royer M., LLD & LED: *Choosing the Right Light Loss Factor for LED Street Lighting*, IES Street and Area Lighting Conference, Nashville, 2014.



# OPTIMIZATION OF PHOTOMETRIC QUANTITIES FOR ROAD LIGHTING FREEWAYS IN INDONESIA

## ORIGINALITY REPORT

12%

SIMILARITY INDEX

9%

INTERNET SOURCES

6%

PUBLICATIONS

8%

STUDENT PAPERS

## PRIMARY SOURCES

1	Submitted to Universitas International Batam Student Paper	5%
2	Submitted to School of Business and Management ITB Student Paper	1%
3	Sędziwy, Adam. "A New Approach to Street Lighting Design", LEUKOS The Journal of the Illuminating Engineering Society of North America, 2015. Publication	1%
4	Road Lighting, 2015. Publication	1%
5	Submitted to Universiti Teknologi MARA Student Paper	1%
6	<a href="http://www.researchgate.net">www.researchgate.net</a> Internet Source	<1%
7	<a href="http://www.tandfonline.com">www.tandfonline.com</a> Internet Source	<1%

8	<a href="http://www.springerprofessional.de">www.springerprofessional.de</a> Internet Source	<1 %
9	<a href="http://ejournal.unmus.ac.id">ejournal.unmus.ac.id</a> Internet Source	<1 %
10	Ardian Ulvan, Melvi Ulvan, Robert Bestak. "Integrated IMS-femtocell testbed", 2013 36th International Conference on Telecommunications and Signal Processing (TSP), 2013 Publication	<1 %
11	<a href="http://pure.tue.nl">pure.tue.nl</a> Internet Source	<1 %
12	<a href="http://www.gms-fop.de">www.gms-fop.de</a> Internet Source	<1 %
13	<a href="http://www.matec-conferences.org">www.matec-conferences.org</a> Internet Source	<1 %
14	Road Lighting, 1980. Publication	<1 %
15	Yolania Sari, Muhammad Halley Yudhistira. "Bad light, bad road, or bad luck? The associations of road lighting and road surface quality on road crash severities in Indonesia", Case Studies on Transport Policy, 2021 Publication	<1 %
16	<a href="http://www.iieta.org">www.iieta.org</a> Internet Source	<1 %

17

Bambang Suhardi, Farid Ishartomo, Jafri Mohd Rohani. "Prohibitory traffic signs violation by well-educated young drivers based on situation scenarios", Cogent Engineering, 2021

Publication

<1 %

---

Exclude quotes Off

Exclude matches Off

Exclude bibliography On